

**KIT VIDEO 2 FILI MONO E BIFAMILIARE MÌRO VIVAVOCE / MIKRA2
ONE- AND TWO-HOUSEHOLD 2 WIRES VIDEO KIT WITH HANDS-FREE
MÌRO AND MIKRA2 PANEL**

KIT VIDÉO 2 FILS MONO ET BI-FAMILLE MÌRO MAINS LIBRES / MIKRA2

Sch./Ref. 1722/93 - 1722/94 (*)

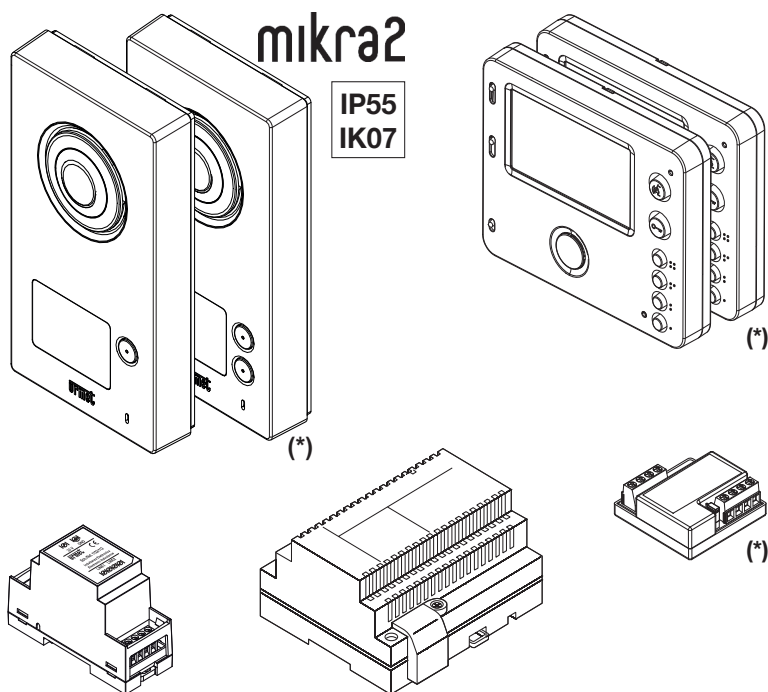

**LIBRETTO DI INSTALLAZIONE ED USO
INSTALLATION AND USE MANUAL
NOTICE D'INSTALLATION ET D'UTILISATION**

(La documentación en español, alemán y flamenco está disponible escaneando el siguiente código QR)

(Die spanische, deutsche und Flämisch Dokumentation kann durch Scannen des folgenden QR-Codes abgerufen werden)

(Spaanse, Duitse en Vlaams documentatie is beschikbaar door de volgende QR-code te scannen)



ITALIANO

INDICE

1	DESCRIZIONE GENERALE	3
2	COMPOSIZIONE DEL KIT	4
3	DISPOSITIVI ACCESSORI	5
4	PARTI DI RICAMBIO.....	6
5	SCHEMA A BLOCCHI DI COLLEGAMENTO.....	7
5.1	Impianto monofamiliare.....	7
5.1.1	Distanze massime tra i dispositivi	7
5.2	Impianto bifamiliare.....	8
5.2.1	Distanze massime tra i dispositivi	8
6	AVVERTENZE PER L'INSTALLATORE	9
7	INSTALLAZIONE DEL VIDEOCITOFONO.....	10
7.1	Descrizione dei morsetti.....	10
7.2	Configurazione dip-switch	10
7.2.1	Codice del videocitofono	10
7.2.2	Associazione pulsante di chiamata a videocitofono	11
7.2.3	Terminazione di linea	11
7.3	Completamento dell'installazione	11
7.4	Programmazione della funzione intercomunicante	11
8	INSTALLAZIONE DELL'ALIMENTATORE.....	12
8.1	Collegamento dell'alimentatore	12
8.2	Descrizione dei morsetti.....	13
9	INSTALLAZIONE DELLA POSTAZIONE DI CHIAMATA	14
9.1	Descrizione dei componenti.....	14
9.2	Modalità di Installazione.....	15
9.3	Descrizione dei morsetti.....	16
9.4	Regolazione tempo attivazione serratura elettrica pedonale	16
9.5	Regolazione accensione/spegnimento led telecamera.....	16
9.6	Regolazione livello fonico altoparlante.....	17
10	FUNZIONAMENTO	17
10.1	Descrizione frontale del videocitofono.....	17
10.1.1	Funzione pulsanti	18
10.1.2	Segnalazioni led	18
10.2	Ricezione della chiamata	18
10.3	Gestione della chiamata intercomunicante.....	19
10.4	Palleggiamento video.....	19
10.5	Apertura porte.....	19
10.6	Autoinserzione.....	19
10.7	Esclusione del tono di chiamata	20
10.8	Suoneria supplementare	20
10.9	Scelta del tono di chiamata del videocitofono.....	20
11	CARATTERISTICHE TECNICHE	20
11.1	Legenda simboli.....	21
12	SCHEMI DI COLLEGAMENTO	62
12.1	Collegamento del kit monofamiliare Sch. 1722/93 con 3 videocitofoni in parallelo	62
12.2	Collegamento del kit bifamiliare Sch. 1722/94 con 3 videocitofoni in parallelo ad ogni utenza....	63
12.2.1	Esempio di collegamento al kit di una badenia per la ripetizione della chiamata.....	64
12.2.2	Esempio di collegamento al kit di due serrature elettriche con apertura contemporanea...	64
12.2.3	Legenda schemi videocitofonici.....	65
12.2.4	Note legate agli schemi videocitofonici.....	66
12.3	Collegamento al videocitofono Miro di un modulo E2BPP per la centralizzazione di luci e tapparelle	67

ENGLISH..... 22

FRANÇAIS..... 42

1. DESCRIZIONE GENERALE

I kit videocitofonici Mod. 1722/93 e /94 sono caratterizzati dalla semplicità di installazione grazie all'utilizzo di 2 soli fili non polarizzati per l'interconnessione tra i vari dispositivi.

Le caratteristiche del sistema videocitofonico sono le seguenti:

Sistema

- Kit videocitofonico monofamiliare (Sch. 1722/93) e bifamiliare (Sch. 1722/94) a colori con fonia viva-voce;
- Collegamento di tutti i dispositivi con 2 soli fili non polarizzati;
- Possibilità di collegare l'alimentatore in qualunque posto dell'impianto tra postazione di chiamata e videocitofono;
- Ogni utenza ha la possibilità di disporre fino a 4 videocitofoni (1 "Master" e 3 "Slave") chiamati in parallelo;
- Nessuna alimentazione locale richiesta;
- Tutti i dispositivi rispondono alle direttive CE relativamente alla compatibilità elettromagnetica e direttiva bassa tensione;
- Il sistema è intrinsecamente protetto da disturbi elettromagnetici di tipo statico e impulsivo.

Postazione di chiamata

- Postazione di chiamata con frontale in zama resistente agli agenti atmosferici (IP55);
- Telecamera della postazione di chiamata a colori e illuminazione del soggetto con led;
- Cartellino portanome retroilluminato di colore bianco;
- Conferma di inoltro chiamata con segnalazione acustica con spegnimento dei led di retroilluminazione del cartellino.















Posto interno

- Posti interni videocitofonici viva-voce con schermo a colori da 4,3" formato 16:9;
- Modalità di conversazione a mani libere;
- Melodie di chiamata selezionabili dall'utente tra le 5 disponibili;
- Volume di chiamata regolabile con possibilità di escluderlo completamente (funzione mute).





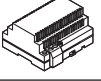





Funzioni base

- Attivazione dell'elettroserratura elettrica pedonale con scarica capacitiva e corrente di mantenimento, con tempo di attivazione programmabile;
- Attivazione di una seconda serratura (passo carraio) con contatto pulito;
- Predisposizione per il collegamento di un pulsante androne per l'attivazione della serratura elettrica pedonale in locale;
- Predisposizione per il collegamento di un pulsante androne per l'attivazione dell'apriporta passo carraio in locale;
- Funzione di autoinserzione sulla postazione di chiamata;
- Possibilità di collegare al videocitofono Master, per la ripetizione della chiamata, una suoneria supplementare.
- Chiamata intercomunicante tra videocitofoni all'interno dello stesso appartamento (funzione disponibile su entrambi i kit videocitofonici).
- Chiamata intercomunicante tra videocitofoni di appartamenti diversi (funzione disponibile solo con kit sch.1722/94).





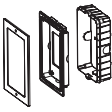



2. COMPOSIZIONE DEL KIT

Descrizione		N°	ID	
Postazione di chiamata (A)	Pulsantiera mod. Mikra2 con 1 tasto di chiamata (presente solo nel kit Sch. 1722/93)	1		A1
	Pulsantiera mod. Mikra2 con 2 tasti di chiamata (presente solo nel kit Sch. 1722/94)	1		A2
	Viti per fissaggio a parete	4		A3
	Tasselli per fissaggio a parete Ø 5mm	4		A4
	Inserto per cacciavite	1		A5
	Cartellino portanome (in quantità 1 nel kit Sch.1722/93, in quantità 2 nel kit Sch.1722/94)	1/2		A6
	Vite a brugola di scorta per chiusura della postazione di chiamata	1		A7
Posto interno (B)	Videocitofono Mod. Miro "Master" (in quantità 1 nel kit Sch.1722/93, in quantità 2 nel kit Sch.1722/94)	1/2		B1
	Staffa per fissaggio a parete (in quantità 1 nel kit Sch.1722/93, in quantità 2 nel kit Sch.1722/94)	1/2		B2
	Viti per fissaggio su scatola incasso (In quantità 2 nel kit Sch.1722/93, in quantità 4 nel kit Sch.1722/94)	2/4		B3
	Viti per fissaggio a parete (In quantità 2 nel kit Sch.1722/93, in quantità 4 nel kit Sch.1722/94)	2/4		B4
	Tasselli per fissaggio a parete Ø 5mm (in quantità 2 nel kit Sch.1722/93, in quantità 4 nel kit Sch.1722/94)	2/4		B5
Alimentatore (C)	Alimentatore video dedicato al kit	1		C1
	Induttanza elettronica	1		C2
	Distributore video (solo nel kit Sch.1722/94)	1		D

3. DISPOSITIVI ACCESSORI

Descrizione		N° max (nell'ipotesi di massima configurazione dell'impianto)	ID	
Serratura elettrica (12 V~ Max 15 VA)		1		OP1
Suoneria supplementare	Sch.9854/43	1		OP2
Videocitofoni supplementari Mod. Miro "Slave" (in quantità 3 con il kit Sch.1722/93, in quantità 6 con il kit Sch.1722/94)	Sch.1722/88	3/6		OP3
Pulsante androne per azionamento serratura elettrica pedonale		1		OP4
Pulsante androne per azionamento apriporta passo carraio		1		OP5
Dispositivo per attivazione apriporta passo carraio (corrente max commutabile 1 A @ 30 V~)		1		OP6
Confezione supporto tavolo per videocitofono (In quantità 4 con il kit Sch.1722/93, in quantità 8 con il kit Sch.1722/94)	Sch.1750/52	4/8 (una per ogni posto interno)		OP7
Scatola incasso per videocitofono (In quantità 4 con il kit Sch.1722/93, in quantità 8 con il kit Sch.1722/94)	Sch.1750/60	4/8 (una per ogni posto interno)		OP8
Scatola incasso per pulsantiera mod. Mikra2	Sch.1723/50	1		OP9
Citofoni supplementari Mod. Miro "Slave" (in quantità 3 con il kit Sch. 1722/93, in quantità 6 con il kit Sch. 1722/94)	Sch. 1122/4	3/6		OP10
Distributore video (Solo nel kit Sch.1722/94)	Sch.1722/55	1		D

4. PARTI DI RICAMBIO

Descrizione			ID
Pulsantiera mod. Mikra2 con 1 tasto di chiamata (presente solo nel kit Sch. 1722/93)	Sch.1722/115		A1
Pulsantiera mod. Mikra2 con 2 tasti di chiamata (presente solo nel kit Sch. 1722/94)	Sch.1722/116		A2
Induttanza elettronica	Sch.1722/112		C2
Alimentatore	Sch.1722/21		C1
Pulsante di ricambio per pulsantiera Bifamiliare	Sch.1722/114		A8
Videocitofono Miro Master/Slave	Sch.1722/88		B/OP3
Citofono Miro Slave	Sch. 1122/4		OP10
Distributore video (Solo nel kit Sch.1722/94)	Sch.1722/55		D

5. SCHEMA A BLOCCHI DI COLLEGAMENTO

5.1. IMPIANTO MONOFAMILIARE

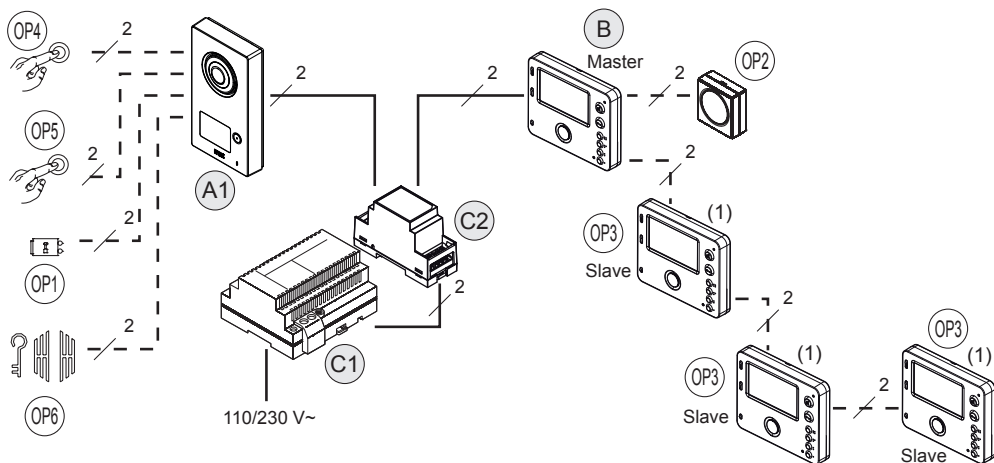

(1) Per le configurazioni dei dip-switch vedere par. 7.2 CONFIGURAZIONE DIP-SWITCH

 La suoneria supplementare OP2 può essere collegata indifferentemente su qualunque videocitofono dell'impianto.

5.1.1. DISTANZE MASSIME TRA I DISPOSITIVI

Impianto base con 1 videocitofono

Tratta	Tipo di cavo							
	Cavo 2Voice	SYT1 (Ø 0,8 mm)	CAT5/CAT6	Doppino telefonico Ø 0,6 mm senza guaina	Cavo singolo 0,5 mm ²	Cavo singolo 0,75 mm ²	Cavo singolo 1 mm ²	Cavo singolo 1,5 mm ²
A1 – videocitofono più distante	150 m	130 m	80 m	100 m	60 m	100 m	100 m	100 m
C1 – C2	0,5 m	0,5 m	0,5 m	0,5 m	0,5 m	0,5 m	0,5 m	0,5 m
C2 – videocitofono più distante	150 m	75 m	40 m	40 m	60 m	100 m	100 m	100 m
A1 – OP1	20 m	10 m *	10 m	10 m	10 m	10 m	20 m	20 m
A1 – OP4	50 m	50 m	30 m	50 m	50 m	50 m	50 m	50 m
A1 – OP5	20 m	10 m *	10 m	10 m	10 m	10 m	20 m	20 m
A1 – OP6	20 m	10 m *	10 m	10 m	10 m	10 m	20 m	20 m
B – OP2	30 m	30 m	10 m	30 m	30 m	30 m	30 m	30 m

* Il cavo SYT1 contiene al suo interno 2 coppie di fili; utilizzandole entrambe è possibile raggiungere la distanza di 20 m.

Impianto fino a 4 videocitofoni

Tratta	Tipo di cavo							
	Cavo 2Voice	SYT1 (Ø 0,8 mm)	CAT5/CAT6	Doppino telefonico Ø 0,6 mm senza guaina	Cavo singolo 0,5 mm ²	Cavo singolo 0,75 mm ²	Cavo singolo 1 mm ²	Cavo singolo 1,5 mm ²
A1 – videocitofono più distante	150 m	130 m	80 m	100 m	60 m	100 m	100 m	100 m
C1 – C2	0,5 m	0,5 m	0,5 m	0,5 m	0,5 m	0,5 m	0,5 m	0,5 m
C2 – videocitofono più distante	150 m	75 m	40 m	40 m	60 m	100 m	100 m	100 m
A1 – OP1	20 m	10 m *	10 m	10 m	10 m	10 m	20 m	20 m
A1 – OP4	50 m	50 m	30 m	50 m	50 m	50 m	50 m	50 m
A1 – OP5	20 m	10 m *	10 m	10 m	10 m	10 m	20 m	20 m
A1 – OP6	20 m	10 m *	10 m	10 m	10 m	10 m	20 m	20 m
B – OP2	30 m	30 m	10 m	30 m	30 m	30 m	30 m	30 m

* Il cavo SYT1 contiene al suo interno 2 coppie di fili; utilizzandole entrambe è possibile raggiungere la distanza di 20 m.

5.2. IMPIANTO BIFAMILIARE

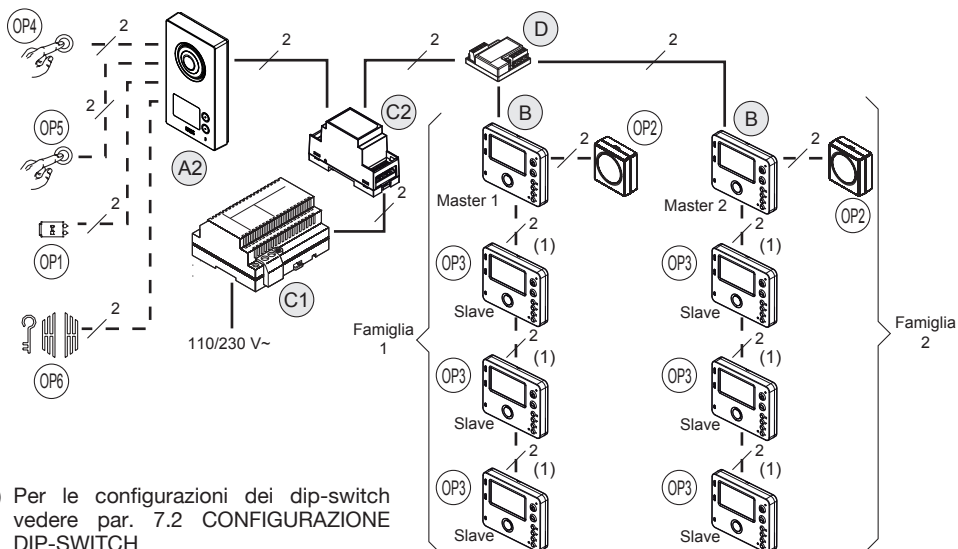

(1) Per le configurazioni dei dip-switch vedere par. 7.2 CONFIGURAZIONE DIP-SWITCH

La suoneria supplementare OP2 può essere collegata indifferentemente su qualunque videocitofono dell'impianto.

5.2.1. DISTANZE MASSIME TRA I DISPOSITIVI

Impianto base con 2 videocitofoni e distributore

Tratta	Tipo di cavo							
	Cavo 2Voice	SYT1 (Ø 0,8 mm)	CAT5/CAT6	Doppino telefonico Ø 0,6 mm senza guaina	Cavo singolo 0,5 mm ²	Cavo singolo 0,75 mm ²	Cavo singolo 1 mm ²	Cavo singolo 1,5 mm ²
A2 – videocitofono più distante	150 m	130 m	60 m	100 m	60 m	100 m	100 m	100 m
C2 – videocitofono più distante	-	50 m	15 m	40 m	20 m	30 m	30 m	30 m
D – videocitofono più distante	50 m	-	-	-	-	-	-	-
C1 – C2	0,5 m	0,5 m	0,5 m	0,5 m	0,5 m	0,5 m	0,5 m	0,5 m
A2 – OP1	20 m	10 m*	10 m	10 m	10 m	10 m	20 m	20 m
A2 – OP4	50 m	50 m	30 m	50 m	50 m	50 m	50 m	50 m
A2 – OP5	20 m	10 m*	10 m	10 m	10 m	10 m	20 m	20 m
A2 – OP6	20 m	10 m*	10 m	10 m	10 m	10 m	20 m	20 m
B – OP2	30 m	30 m	10 m	30 m	30 m	30 m	30 m	30 m

* Il cavo SYT1 contiene al suo interno 2 coppie di fili; utilizzandole entrambe è possibile raggiungere la distanza di 20 m.

Impianto fino a 8 videocitofoni e distributore

Tratta	Tipo di cavo							
	Cavo 2Voice	SYT1 (Ø 0,8 mm)	CAT5/CAT6	Doppino telefonico Ø 0,6 mm senza guaina	Cavo singolo 0,5 mm ²	Cavo singolo 0,75 mm ²	Cavo singolo 1 mm ²	Cavo singolo 1,5 mm ²
A2 – videocitofono più distante	150 m	100 m	60 m	100 m	60 m	100 m	100 m	100 m
C2 – videocitofono più distante	-	40 m	15 m	15 m	-	-	-	-
D – videocitofono più distante	50 m	-	-	-	20 m	30 m	30 m	30 m
C1 – C2	0,5 m	0,5 m	0,5 m	0,5 m	0,5 m	0,5 m	0,5 m	0,5 m
A2 – OP1	20 m	10 m*	10 m	10 m	10 m	10 m	20 m	20 m
A2 – OP4	50 m	50 m	30 m	50 m	50 m	50 m	50 m	50 m
A2 – OP5	20 m	10 m*	10 m	10 m	10 m	10 m	20 m	20 m
A2 – OP6	20 m	10 m*	10 m	10 m	10 m	10 m	20 m	20 m
B – OP2	30 m	30 m	10 m	30 m	30 m	30 m	30 m	30 m

* Il cavo SYT1 contiene al suo interno 2 coppie di fili; utilizzandole entrambe è possibile raggiungere la distanza di 20 m.

6. AVVERTENZE PER L'INSTALLATORE

Leggere attentamente le avvertenze contenute nel presente documento in quanto forniscono importanti indicazioni riguardanti la sicurezza di installazione, uso e manutenzione.

- I dispositivi facenti parte del kit dovranno essere destinati solo all'uso per il quale sono stati espressamente concepiti. Ogni altro uso è da considerarsi improprio. Il costruttore non può essere considerato responsabile per eventuali danni derivanti da usi impropri, ed irragionevoli.
- Ogni parte è stata progettata in modo tale da essere conforme alle norme vigenti.
- L'esecuzione dell'impianto deve essere rispondente alle norme vigenti. Tutti gli apparecchi costituenti l'impianto, devono essere destinati esclusivamente all'uso per cui sono stati concepiti.
- Dopo aver tolto dall'imballaggio i vari componenti assicurarsi della loro integrità.
- Gli elementi dell'imballaggio (sacchetti di plastica, polistirolo espanso, ecc.) non devono essere lasciati alla portata dei bambini, in quanto potenziali fonti di pericolo.
- Prevedere a monte degli apparecchi un idoneo interruttore di sezionamento e protezione con distanza di apertura dei contatti di almeno 3mm.
- Prima di collegare i dispositivi di alimentazione accertarsi che i dati di targa siano rispondenti a quelli della rete di distribuzione.
- Non ostruire le aperture o fessure di ventilazione o smaltimento calore.
- Prima di effettuare qualsiasi operazione di pulizia o di manutenzione, disinserire i dispositivi dalla rete di alimentazione elettrica, spegnendo l'interruttore dell'impianto.
- Non usare per la pulizia prodotti spray.
- In caso di guasto e/o di cattivo funzionamento dei prodotti contenuti nel kit togliere l'alimentazione mediante l'interruttore generale e non manometterlo.
- Per l'eventuale riparazione rivolgersi solamente ad un centro di assistenza tecnico autorizzato dal costruttore.
- Provvedere ad una idonea ventilazione.
- Non usare cavi di prolunga per il cavo rete di alimentazione.
- Nel caso di infiltrazione di liquidi o oggetti all'interno dell'apparecchio, affidare lo stesso a personale qualificato per controllo ed eventuale riparazione.
- Per le riparazioni usare esclusivamente le parti di ricambio fornite dalla casa.
- L'installatore deve assicurarsi che le informazioni per l'utente siano presenti sugli apparecchi derivati.
- Il mancato rispetto di quanto sopra può compromettere la sicurezza dell'installazione.
- Questo documento dovrà essere sempre allegato all'apparecchio.
- Il simbolo di fulmine con freccia all'interno di un triangolo equilatero segnala la presenza di tensioni pericolose.



- Non aprire i dispositivi se non espressamente indicato nel presente libretto istruzioni.
- Il simbolo di punto esclamativo all'interno di un triangolo equilatero segnala componenti critici per la sicurezza, usare pertanto solo componenti forniti dalla casa.



7. INSTALLAZIONE DEL VIDEOCITOFONO

Murare la scatola incasso all'altezza indicata nel disegno seguente.
Fissare la staffa alla scatola incasso o a muro come indicato.
Programmare i dip-switch di programmazione.

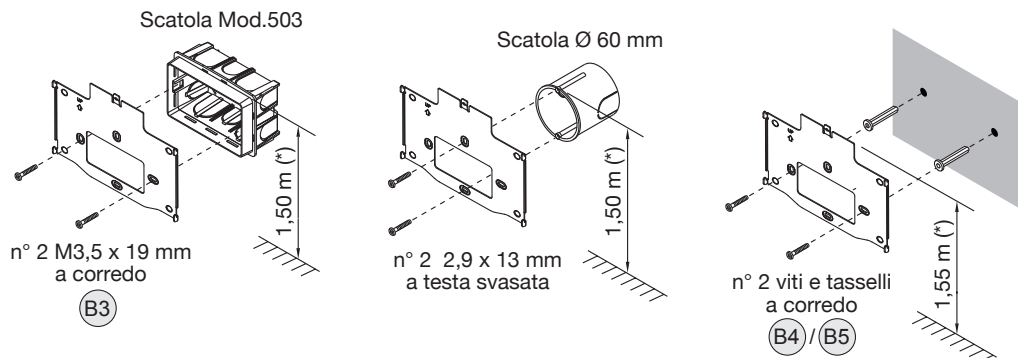

(*) Nel caso di persone con disabilità o specifiche necessità di tipo D1 (con età avanzata), D2 (con difficoltà motoria degli arti inferiori) e D3 (con difficoltà motoria degli arti superiori), **il centro del dispositivo** dovrà essere posizionato ad una altezza compresa tra 110 cm e 130 cm rispetto al piano di calpestio. Per ulteriori dettagli vedere la Norma tecnica CEI 64-21:2016-12 – Ambienti residenziali. Impianti adeguati all'utilizzo da parte di persone con disabilità o specifiche necessità.

7.1. DESCRIZIONE DEI MORSETTI

- ⊗] LINE IN Ingresso Linea BUS
- ⊗] LINE OUT Uscita Linea BUS
- ⊗ Z } Uscita per collegamento di suonerie supplementari (OP2)
- ⊗ K }
- ⊗ X2 } Pulsante ●●
- ⊗ X1 }
- ⊗ Y2 } Pulsante ●●
- ⊗ Y1 }



7.2. CONFIGURAZIONE DIP-SWITCH

7.2.1 Codice del videocitofono

Qualora si desideri installare dei videocitofoni "Slave" è necessario impostare su ogni posto interno il relativo codice tramite i dip-switch 1 e 2.



Tipologia di videocitofono	Posizione dip-switch	Tipologia di videocitofono	Posizione dip-switch
Videocitofono "Master"		Videocitofono "Slave" n° 1	
Videocitofono "Slave" n° 2		Videocitofono "Slave" n° 3	

7.2.2 Associazione pulsante di chiamata a videocitofono

	Posizione dip-switch		Posizione dip-switch
Videocitofono associato al pulsante di chiamata 1		Videocitofono associato al pulsante di chiamata 2	

7.2.3 Terminazione di linea

È necessario attivare la terminazione di linea sul videocitofono collegato alla fine di una linea, che non riparta con una nuova tratta dai morsetti LINE OUT.

	Posizione dip-switch		Posizione dip-switch
Terminazione inserita (default)		Terminazione non inserita	

7.3. COMPLETAMENTO DELL'INSTALLAZIONE

Eseguire i collegamenti.

Fissare il videocitofono alla staffa.

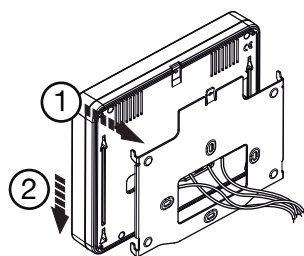

 Per rimuovere il videocitofono dalla staffa, inserire la punta di un cacciavite nella sede come indicato in figura e spingere il videocitofono verso l'alto.

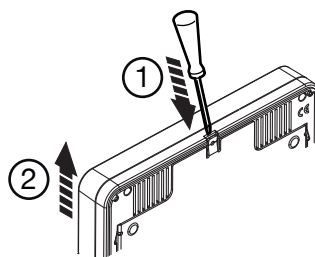

7.4. PROGRAMMAZIONE DELLA FUNZIONE INTERCOMUNICANTE

È possibile programmare 2 pulsanti (● e ●) per effettuare le chiamate intercomunicanti.

Con il kit sch. 1722/93 è possibile chiamare fino a 2 videocitofoni nello stesso appartamento.

Con il kit sch. 1722/94 è possibile chiamare in alternativa:

- fino a 2 videocitofoni nello stesso appartamento,
- 1 videocitofono nello stesso appartamento e tutti i videocitofoni dell'altro appartamento.

La programmazione è la seguente:

- Recarsi presso il posto interno da programmare come chiamante (posto interno A).
- Premere e tenere premuto il tasto ● per più di 5 secondi; la conferma dell'entrata in programmazione avviene con il lampeggio lento del led rosso e l'emissione di 3 beep di conferma.
- Premere il pulsante da programmare come "chiamante" (● oppure ●) per almeno 3 secondi fino al tono di conferma.
- Recarsi presso il posto interno che dovrà essere chiamato da quel pulsante (posto interno B) e premere il pulsante apriporta. I posti interni A e B emettono un bip di avvenuta programmazione.
- Per uscire dallo stato di programmazione premere e tenere premuto il tasto ● per più di 5 secondi sul posto interno A.

 Comunque trascorsi 10 minuti il dispositivo esce dallo stato di programmazione salvando i parametri variati.

Con il kit sch. 1722/94 la chiamata ad un videocitofono del secondo appartamento, farà necessariamente suonare tutti i videocitofoni presenti nell'appartamento.

8. INSTALLAZIONE DELL'ALIMENTATORE

Alimentatore in CAT II 2500 V. L'alimentatore che, una volta installato, è soggetto a tensioni transitorie superiori a quelle della categoria di sovratensione di progetto, necessita di una protezione supplementare delle tensioni transitorie esterne all'apparecchiatura.

L'alimentatore deve essere installato all'interno di un quadro elettrico oppure di un armadietto.

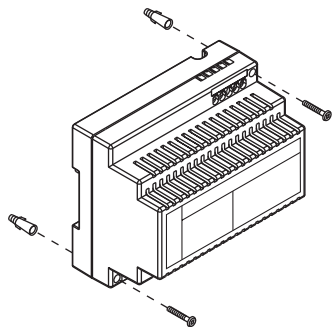

Installazione ad appoggio parete

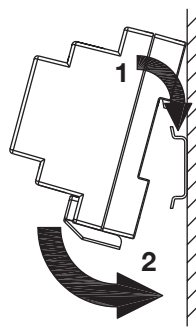

Installazione su barra DIN
(6 moduli da 18 mm)

Il modulo induttanza elettronica può essere fissato a parete tramite la staffa fornita a corredo oppure fissato su barra DIN (2 moduli da 18 mm).

Il modulo induttanza elettronica deve essere installato nello stesso quadro elettrico dell'alimentatore.

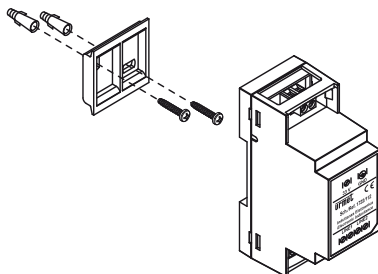

8.1. COLLEGAMENTO DELL'ALIMENTATORE

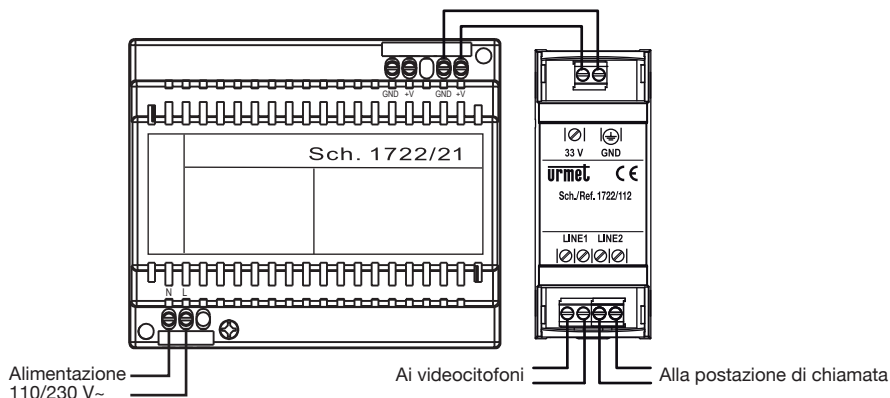

8.2. DESCRIZIONE DEI MORSETTI

Alimentatore Sch. 1722/21

- ⊘ N } Ingresso tensione di alimentazione di rete 110/230 V~
- ⊘ L }
- ⊘ GND } Uscita tensione di alimentazione
- ⊘ +V }

Modulo induttanza elettronica Sch. 1722/112

- ⊘ GND } Ingresso tensione di alimentazione
- ⊘ 33V }
- ⊘] LINE1 Linea BUS 1
- ⊘]
- ⊘] LINE2 Linea BUS 2
- ⊘]

9. INSTALLAZIONE DELLA POSTAZIONE DI CHIAMATA

9.1. DESCRIZIONE DEI COMPONENTI

VISTA FRONTALE

Pulsantiera con 1 tasto
di chiamata Sch. 1722/115
(Kit Sch. 1722/93)

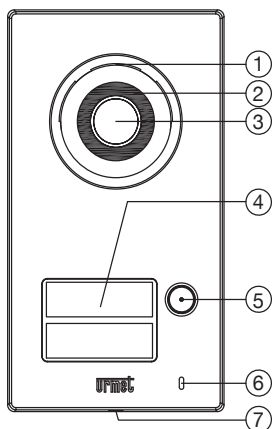

Pulsantiera con 2 tasti
di chiamata Sch. 1722/116
(Kit Sch. 1722/94)

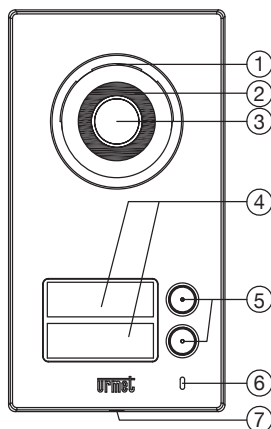

1. Altoparlante
2. Led di illuminazione telecamera
3. Telecamera
4. Cartellino/i portanome
5. Pulsante/i di chiamata
6. Microfono
7. Vite di chiusura frontale

PARTE INTERNA

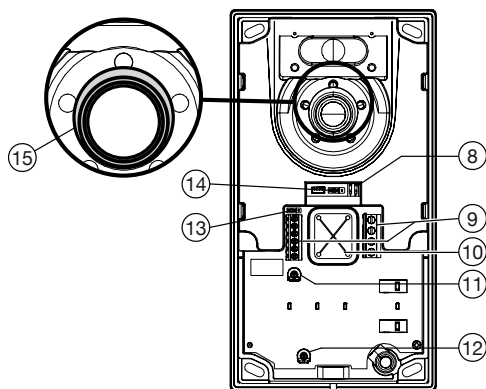

8. Dip-switch
9. Morsettiere
10. Foro per passaggio cavi
11. Trimmer regolazione volume altoparlante
12. **Non variare la posizione di questo trimmer**
13. Jumper per l'accensione dei led della telecamera
14. **Non variare la posizione di questo Jumper**
15. Guarnizione antiriflesso

9.2. MODALITÀ DI INSTALLAZIONE

- Installare la pulsantiera all'altezza indicata verificando che il soggetto rientri nel campo inquadrato dalla telecamera;
- Collegare i fili alla morsetteria;
- Montare i cartellini portanome sul frontale;
- Eseguire le programmazioni;
- Regolare il livello fonico;
- Chiudere la pulsantiera con la copertura metallica;
- Rimuovere le pellicole di protezione.

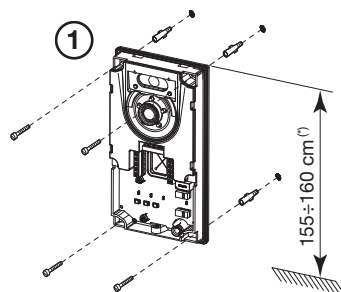
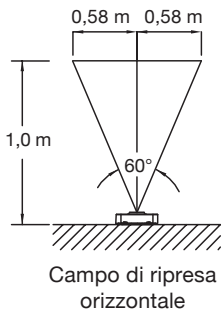
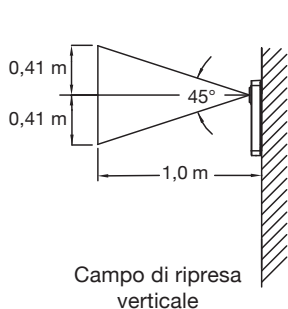

(*) Nel caso di persone con disabilità o specifiche necessità di tipo D1 (con età avanzata), D2 (con difficoltà motoria degli arti inferiori) e D3 (con difficoltà motoria degli arti superiori), il centro del dispositivo dovrà essere posizionato ad una altezza compresa tra 110 cm e 130 cm rispetto al piano di calpestio. Per ulteriori dettagli vedere la Norma tecnica CEI 64-21:2016-12 – Ambienti residenziali. Impianti adeguati all'utilizzo da parte di persone con disabilità o specifiche necessità.

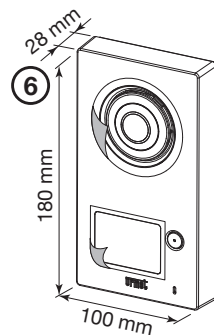
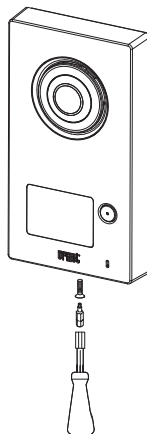
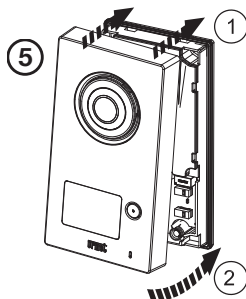
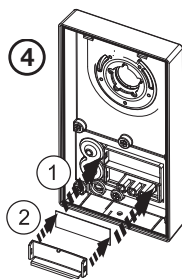
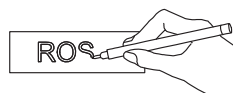
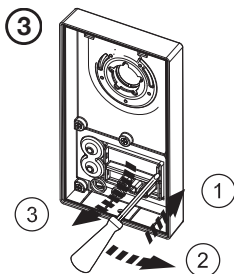
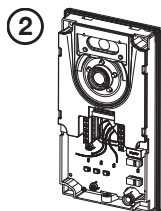

9.3. DESCRIZIONE DEI MORSETTI

- ⊗] AP1 Morsetti per pulsante per serratura elettrica pedonale (OP4)
- ⊗] AP2 Morsetti per pulsante per apriporta passo carraio (OP5)
- ⊗ C } Contatto pulito azionamento apriporta passo carraio (OP6) - massima commutazione 1 A @ 30 V
- ⊗ NO }
- ⊗ L } Linea BUS
- ⊗ L }
- ⊗ SE2 } Azionamento serratura elettrica pedonale (OP1) - massima commutazione 12 V~ 15 VA
- ⊗ SE1 }

9.4. REGOLAZIONE TEMPO ATTIVAZIONE SERRATURA ELETTRICA PEDONALE

Il tempo di attivazione della serratura elettrica pedonale può essere regolato con i dip-switch presenti nella postazione di chiamata:

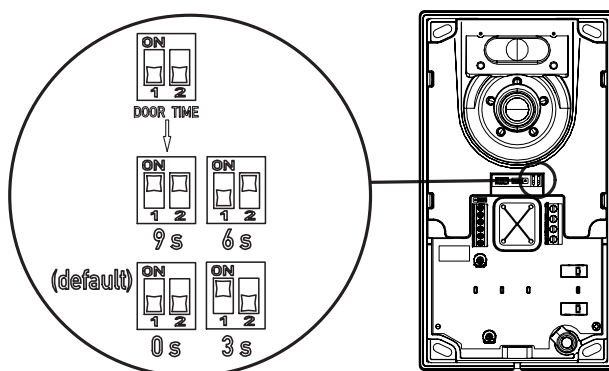

9.5. REGOLAZIONE ACCENSIONE/SPEGNIMENTO LED TELECAMERA

La regolazione del jumper presente nella parte interna del dispositivo permette l'accensione o lo spegnimento del led della telecamera. Questa operazione dovrà essere effettuata solamente se la postazione di chiamata è installata in un'area in cui è garantita una illuminazione sufficiente durante tutte le ore del giorno e della notte.

Per disattivare i led della telecamera agire sul jumper indicato in figura.

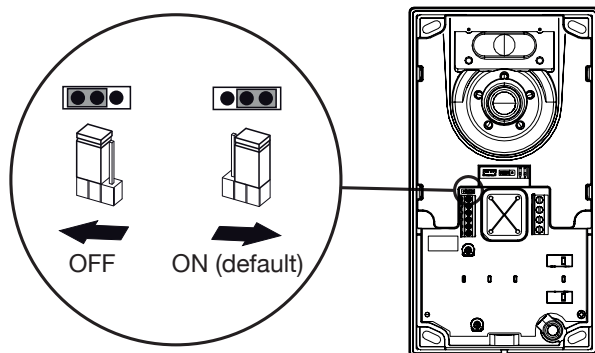

9.6. REGOLAZIONE LIVELLO FONICO ALTOPARLANTE

I livelli fonici sono tarati di fabbrica in modo da non dover essere variati nella maggioranza delle installazioni.

Qualora fosse necessario modificarli, agire con un cacciavite sull'apposita regolazione del volume dell'altoparlante.

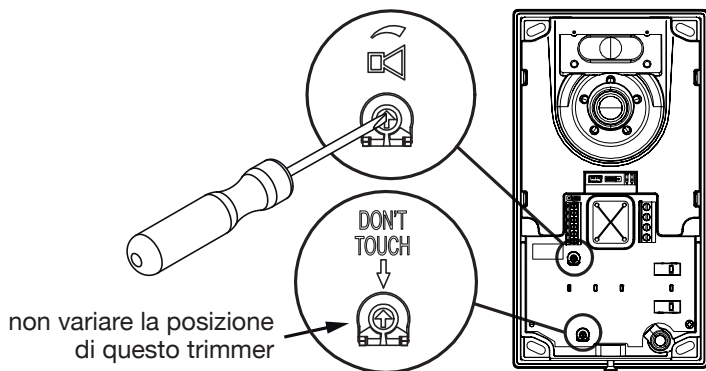

10. FUNZIONAMENTO

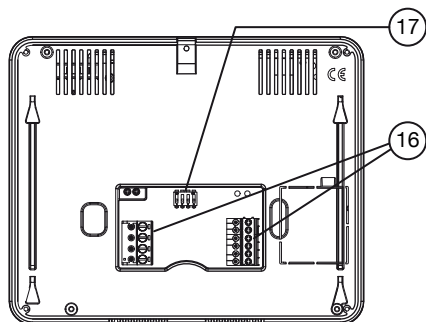
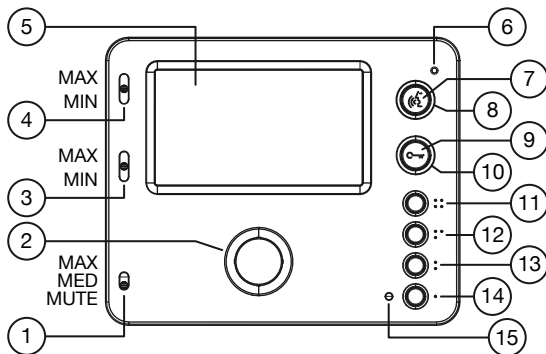

10.1. DESCRIZIONE FRONTALE DEL VIDEOCITOFONO

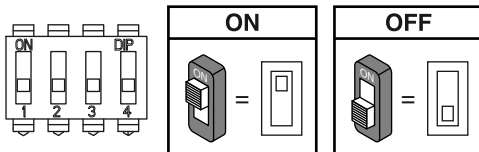

1. Regolazione volume di chiamata (MAX, MEDIO, MUTE)
2. Altoparlante di chiamata e conversazione
3. Regolazione luminosità display
4. Regolazione intensità colore display
5. Display 4,3" formato 16:9
6. Microfono
7. Pulsante attivazione/disattivazione fonia
8. Led rosso/verde presente sotto al pulsante
9. Pulsante apriporta
10. Led verde presente sotto al pulsante
11. Pulsante per connessione a dispositivi Yokis; contatti Y1, Y2: max 50 mA 12 V=
12. Pulsante per connessione a dispositivi Yokis; contatti X1, X2: max 50 mA 12 V=
13. Pulsante : autoinserzione
14. Pulsante : apriporta passo carraio (OP6)
15. Led rosso di programmazione
16. Morsetti per il collegamento al sistema
17. Dip-switch di configurazione:
 - n.1-2: codice del videocitofono;
 - n.3: associazione pulsante di chiamata a videocitofono;
 - n.4: terminazione di linea.





10.1.1 Funzione pulsanti

Stato Pulsante	RIPOSO	ATTESA SGANCIO (ricezione chiamata)	IN FONIA	RIPOSO E TASTO  PREMUTO	STATO DI PROGRAMMAZIONE (SOLO CON VIDEOCITOFONO A RIPOSO)
	[Conferma associazione funzione intercom fra videocitofoni]	Apriporta pedonale	Apriporta pedonale	Apriporta pedonale	---
	---	Attivazione della fonia	Se premuto brevemente attiva o termina la conversazione	---	---
•	Autoinserzione	Palleggiamento video	---	Chiamata intercomunicante 2 programmabile (default: non programmato)	[Richiesta associazione funzione intercom fra videocitofoni] (*)
•	Entrata in programmazione (se premuto per 5 secondi)	Apriporta passo carraio	Apriporta passo carraio	Chiamata intercomunicante 1 programmabile (default: non programmato)	Scelta suoneria chiamata citofonica (5 suonerie diverse) / [Richiesta associazione funzione intercom fra videocitofoni] (*)





(*) Se premuto per almeno 3 secondi fino al tono di conferma (vedere par. 7.4 *PROGRAMMAZIONE DELLA FUNZIONE INTERCOMUNICANTE*)

10.1.2 Segnalazioni led

8. Led presente sotto al pulsante 
 - Rosso: chiamata in corso
 - Verde: conversazione in corso
10. Led verde presente sotto al pulsante 
 - Acceso fisso: possibilità di apertura porta
15. Led rosso di programmazione
 - Acceso lampeggiante: stato di programmazione attivo

10.2. RICEZIONE DELLA CHIAMATA

Se viene premuto il pulsante di chiamata si verificheranno i seguenti eventi:

- I led della telecamera si illuminano;
- La retroilluminazione del cartellino portanome si spegne temporaneamente;
- I videocitofoni emettono il tono di chiamata;
- Sul videocitofono “Master” appaiono le immagini riprese dalla telecamera della postazione di chiamata e si illuminano il tasto  di colore verde e il tasto  di colore rosso.
- Sui videocitofoni “Slave” si illuminano il tasto  di colore verde e il tasto  di colore rosso.

 Se entro 3 minuti dalla chiamata non si preme nessun tasto il videocitofono torna nella condizione di riposo.

A seguito di una chiamata è possibile eseguire sul videocitofono “Master” l’operazione descritta di seguito:







- Attivare la fonia con il tasto  : dopo aver attivato la fonia il tasto si illumina di colore verde e si può

conversare con il chiamante per un tempo massimo di 3 minuti (la conversazione può essere interrotta in qualunque momento ripremendo il tasto );

 Durante il periodo in cui la fonia è attiva i led di retroilluminazione del cartellino portanome della postazione di chiamata si spengono.

10.3. GESTIONE DELLA CHIAMATA INTERCOMUNICANTE

Per effettuare una chiamata intercomunicante:

- Premere il pulsante  che inizierà a lampeggiare di colore verde;
- Premere il pulsante  o  per l'invio della chiamata al videocitofono con il quale si vuole stabilire una conversazione (vedere la procedura di programmazione pulsanti al § 7.4 PROGRAMMAZIONE DELLA FUNZIONE INTERCOMUNICANTE);
- Durante l'attesa della risposta il led del pulsante  è acceso fisso di colore rosso;
- Quando il videocitofono chiamato risponde, il led del pulsante  rimane acceso fisso di colore verde per tutto il tempo della conversazione;
- Ripremere il tasto  per interrompere la conversazione.

10.4. PALLEGGIAMENTO VIDEO



Se nell'impianto sono presenti dei videocitofoni "Slave" (OP3), a seguito di una chiamata, il tono di chiamata viene emesso in modo alternato dai vari videocitofoni. Se la chiamata proviene da una postazione di chiamata videocitofonica, l'interno "Master" pilota anche l'accensione del videocitofono. In tal caso, durante tutto il tempo di attesa sgancio (3 minuti dalla chiamata), gli altri interni possono accendere il loro videocitofono tramite la pressione del pulsante di autoinserzione  (funzione 'palleggiamento video') fino alla risposta da uno dei videocitofoni.

Dopo l'attivazione della fonia l'immagine della telecamera principale sarà presente sul solo posto interno che ha risposto.

È quindi normale che l'immagine della telecamera sia presente su un solo posto interno per volta.



10.5. APERTURA PORTE

Durante una chiamata, durante una comunicazione (fonia attiva) o durante l'autoinserzione è possibile

- Attivare la serratura elettrica pedonale con il tasto  ;
- Attivare l'apriporta passo carraio con il tasto  .



10.6. AUTOINSERZIONE

Premendo il pulsante  si può visualizzare sul videocitofono l'immagine ripresa dalla telecamera della postazione di chiamata.

L'autoinserzione avviene in modo silenzioso (senza attivare la fonia) e mantenendo i led della telecamera della postazione di chiamata spenti. Durante l'autoinserzione, sul monitor del videocitofono appaiono le immagini riprese dalla telecamera e si illuminano il tasto  di colore verde e il tasto  di colore rosso.

Per uscire dalla funzione autoinserzione ripremere il pulsante  (comunque trascorsi 3 minuti il dispositivo si spegne).

Quando il videocitofono visualizza le immagini della postazione di chiamata è possibile:

- Attivare la fonia per dialogare con l'esterno premendo il tasto  (la conversazione può essere interrotta in qualunque momento ripremendo il tasto ).

 Con l'attivazione della fonia si attiveranno anche i led della telecamera.

10.7. ESCLUSIONE TONO DI CHIAMATA

È possibile regolare il volume di chiamata fino ad escludere la suoneria (Mute) agendo sul cursore a slitta 1 (vedere par. 10.1 DESCRIZIONE FRONTALE DEL VIDEOCITOFONO).

Lo stato di mute è evidenziato da un'indicazione di colore rosso visibile nella parte alta del cursore.

 Se il cursore è nella posizione MUTE, in caso di chiamata il modulo video del videocitofono si accenderà; inoltre anche tutte le segnalazioni acustiche (beep) e le eventuali suonerie supplementari saranno disabilitate.

10.8. SUONERIA SUPPLEMENTARE

I videocitofoni sono dotati di una coppia di morsetti (K, Z) per il collegamento di una suoneria supplementare. Tale suoneria viene pilotata contemporaneamente alla generazione del tono di chiamata.

10.9. SCELTA DEL TONO DI CHIAMATA DEL VIDEOCITOFONO

In impianti con più videocitofoni può essere utile differenziare il tono di chiamata dei vari dispositivi.

- Per accedere alla scelta del tono di chiamata, con impianto a riposo, mantenere il tasto ● premuto per più di 5 secondi, la conferma dell'entrata in programmazione avviene con il lampeggio lento del led rosso e l'emissione di 3 beep di conferma;
- Premere il tasto ● ;
- Il videocitofono emette il tono di chiamata;
- Ripremere il tasto ● per variare il tono;
- Per uscire dalla programmazione tenere premuto il tasto ● fino a quando si sentono 3 beep di conferma e il led rosso di programmazione smette di lampeggiare.

 Comunque trascorsi 10 minuti il dispositivo esce dallo stato di programmazione salvando i parametri variati.

11. CARATTERISTICHE TECNICHE

Alimentatore

Alimentazione: 100-250 V~ ; 50/60 Hz
Potenza: 50 W max
Uscita secondario: 34,5 V --- 0,6 A continui (+0,6 A intermittenti)
Potenza dissipata dopo 1 ora di lavoro: Max 50 Wh (180 kJ)
Dimensioni (LxPxH): 108 (6 moduli DIN) x 90 x 61 mm

Induttanza elettronica

Dimensioni (LxPxH): 36 (2 moduli DIN) x 103 x 57 mm

Videocitofono

Tensione di alimentazione: 34,5 V ---
Assorbimento Massimo: 150 mA
A riposo (configurazione base): 8 mA
Potenza assorbita in funzione: max 6 W
Display a cristalli liquidi: 4,3" retroilluminato formato 16:9
Dimensioni schermo: 95 x 50 mm
Risoluzione: 480H x 272V pixel
Ritardo accensione: 2 s Max
Capsula trasmittente: microfono ad elettrete
Capsula ricevente: altoparlante 45 Ω
Temperatura di funzionamento: -5 ÷ +45° C
Umidità max: 90% UR
Dimensioni (L x P x H) 160 x 26 x 130 mm



Postazione di chiamata

Assorbimento Massimo: 300 mA
A riposo (configurazione base): 50 mA

Potenza assorbita in funzione: **max 10,4 W**
 Dimensioni (LxPxH): **100 x 180 x 28 mm**
 Dimensioni cartellino portanome: **48 x 15 mm**
 Illuminazione cartellini e pulsanti: **LED bianchi**
 Grado di protezione degli involucri: **IP55**
 Grado di protezione contro gli impatti meccanici: **IK07**
 Temperatura di funzionamento: **-10 ÷ +50° C**
 Umidità max: **90% UR**
 Portata max contatto C-NO: **1 A @ 30 V**
 Portata max contatto SE1-SE2: **12 V~ Max 15 VA**

 *I cavi impiegati devono rispondere alla norma IEC 60332-1-2 se di sezione 0,5 mm² o superiore, oppure alla norma IEC 60332-2-2 se di sezione inferiore a 0,5 mm².*

11.1. LEGENDA SIMBOLI

Simbolo	Spiegazione
	Tensione di alimentazione continua
	Tensione di alimentazione alternata
	Alimentatore dotato di un doppio isolamento
	Riferirsi al manuale d'installazione del dispositivo
	PERICOLO - Presenza di tensioni pericolose
	PERICOLO - Presenza di componenti critici per la sicurezza

ENGLISH

CONTENTS

1	GENERAL DESCRIPTION.....	23
2	KIT COMPOSITION	24
3	ACCESSORY DEVICES	25
4	SPARE PARTS.....	26
5	CONNECTION BLOCK CHART	27
5.1	One-household system	27
5.1.1	Maximum distances between devices.....	27
5.2	Two-household system.....	28
5.2.1	Maximum distances between devices.....	28
6	WARNINGS FOR INSTALLERS	29
7	VIDEO DOOR PHONE INSTALLATION	30
7.1	Description of terminals	30
7.2	Dip-switch configuration	30
7.2.1	Video door phone code.....	30
7.2.2	Call button to video door phone association	30
7.2.3	Line terminal.....	31
7.3	Installation completion	31
7.4	Programming the intercom function	31
8	POWER SUPPLY INSTALLATION	32
8.1	Power supply connection.....	32
8.2	Description of terminals	33
9	CALLING STATION INSTALLATION.....	34
9.1	Description of components.....	34
9.2	Installation method.....	35
9.3	Description of the terminals	36
9.4	Pedestrian gate electric lock activation time setting.....	36
9.5	Camera led on / off adjustment.....	36
9.6	Speaker sound level adjustment	37
10	OPERATION	37
10.1	Description of the front of the video door phone.....	37
10.1.1	Button functions	38
10.1.2	Indicator LEDs	38
10.2	Call reception	38
10.3	Intercom call management.....	39
10.4	Video switching	39
10.5	Opening the doors	39
10.6	Auto power-on	39
10.7	Call tone muting.....	39
10.8	Supplementary ringer.....	39
10.9	Video door phone call tone selection.....	40
11	TECHNICAL SPECIFICATIONS	40
11.1	Key to symbols.....	41
12	CONNECTION DIAGRAMS	62
12.1	Connection of one-household kit Ref. 1722/93 with 3 video door phones in parallel	62
12.2	Connection of two-household kit Ref. 1722/94 with 3 video door phones in parallel for each user	63
12.2.1	Example of connection of call repeat brass bell to the kit	64
12.2.2	Example of connection of two simultaneously opening electric locks to the kit	64
12.2.3	Key to video door phone diagrams.....	65
12.2.4	Notes on video door phone diagrams	66
12.3	Connection of a E2BPP module to the Miro video door phone for the centralisation of lights and rollers.....	67

1. GENERAL DESCRIPTION

The Video Door Phone kits model Mod. 1722/93 and /94 are easy to install: only two non-polarised wires are needed to interconnect all system devices.

The features of the video door phone system are:

System

- One-household (Ref. 1722/93) and two-household (Ref. 1722/94) hands-free colour video door phone kit;
- Connection of all devices using only two non-polarised wires.
- The power supply can be connected anywhere in the system between the calling station and the video door phone;
- Each user can manage up to 4 video door phones (1 “Master” and 3 “Slaves”), called in parallel;
- No local power needed.
- All devices comply with EC directives in the matter of electromagnetic compatibility and to the low voltage directive.
- The system is intrinsically protected from static and pulse electromagnetic interference.

Calling station

- Calling station with weatherproof zama front panel (IP55).
- Call station colour camera and LED lighting of caller.
- Backlit white name holder tag.
- Call forward confirmation with auditory signalling and by switching name tag backlighting LEDs off.















Apartment station

- Hands-free video door phone apartment stations with 4.3” 16:9 colour screen;
- Hands-free conversation mode;
- Calling tones selectable by user (five available tones);
- Adjustable calling volume with mute function.
-











Basic functions

- Pedestrian electric lock activation via capacitance discharge and hold current, programmable activation time.
- Activation of a second dry lock (garage gate).
- Setup for connecting a hall button for locally operating the pedestrian gate electric lock.
- Setup for connecting a hall button for locally operating the garage gate electric lock.
- Calling station auto-on function.
- Option of connecting an additional door bell to the Master video door phone to redial calls.
- Intercom call between video door phones in the same apartment (function available for both video door phone kits).
- Intercom call between video door phones in different apartments (function only available with kit Ref.1722/94).



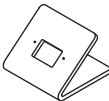





2. KIT COMPOSITION

Description		No.	ID	
Calling station (A)	Mikra 2 Panel with 1 calling button (only in kit Ref.1722/93)	1		A1
	Mikra 2 Panel with 2 calling buttons (only in kit Ref.1722/94)	1		A2
	Screws for fixing to wall	4		A3
	Bolts for fastening to wall Ø 5mm (0.20")	4		A4
	Screwdriver insert	1		A5
	Name tag (quantity: 1 in kit Ref.1722/93, quantity: 2 in kit Ref.1722/94)	1/2		A6
	Spare Allen screw for closing calling station	1		A7
Apartment station (B)	Miro "Master" video door phone (quantity: 1 in kit Ref.1722/93, quantity: 2 in kit Ref.1722/94)	1/2		B1
	Bracket for fixing to wall (quantity: 1 in kit Ref.1722/93, quantity: 2 in kit Ref.1722/94)	1/2		B2
	Screws for fastening on flush-mounted box (quantity: 2 in kit Ref.1722/93, quantity: 4 in kit Ref.1722/94)	2/4		B3
	Screws for fixing to wall (quantity: 2 in kit Ref.1722/93, quantity: 4 in kit Ref.1722/94)	2/4		B4
	Bolts for fastening to wall Ø 5mm (0.20") (quantity: 2 in kit Ref.1722/93, quantity: 4 in kit Ref.1722/94)	2/4		B5
Power supply units (C)	Dedicated video power supply in the kit	1		C1
	Electric inductor	1		C2
	Video distributor (only in kit Ref.1722/94)	1		D

3. ACCESSORY DEVICES

Description		Max. no. (maximum system configuration)	ID	
Electric lock (12V~ Max 15VA)		1		OP1
Supplementary ringer	Ref.9854/43	1		OP2
Additional video door phones Model Miro "Slave" (3 units with kit Ref.1722/93, 6 units with kit Ref.1722/94)	Ref.1722/88	3/6		OP3
Hall button for operating pedestrian gate electric lock		1		OP4
Hall button for operating garage gate lock		1		OP5
Garage gate lock activation device (max switching current 1 A @ 30 V $\overline{\text{---}}$)		1		OP6
Table-top stand for video door phone (4 units with kit Ref.1722/93, 8 units with kit Ref.1722/94)	Ref.1750/52	4/8 (one for each apartment station)		OP7
Video door phone flush mounting box (4 units with kit Ref.1722/93, 8 units with kit Ref.1722/94)	Ref.1750/60	4/8 (one for each apartment station)		OP8
Mikra2 panel flush-mounting box	Ref.1723/50	1		OP9
Additional door phones Model Miro "Slave" (3 units with kit Ref.1722/93, 6 units with kit Ref.1722/94)	Ref. 1122/4	3/6		OP10
Video distributor (only in kit Ref.1722/94)	Ref.1722/55	1		D

4. SPARE PARTS

Description			ID
Mikra 2 Panel with 1 calling button (only in kit Ref.1722/93)	Ref. 1722/115		A1
Mikra 2 Panel with 2 calling buttons (only in kit Ref.1722/94)	Ref. 1722/116		A2
Electric inductor	Ref.1722/112		C2
Power supply units	Ref.1722/21		C1
Replacement button for two-household button panel	Ref.1722/114		A8
Video door phone Mod. Miro "Master/ Slave"	Ref.1722/88		B/OP3
Door phone Miro "Slave"	Ref. 1122/4		OP10
Video distributor (only in kit Ref.1722/94)	Ref.1722/55		D

5. CONNECTION BLOCK CHART

5.1. ONE-HOUSEHOLD SYSTEM

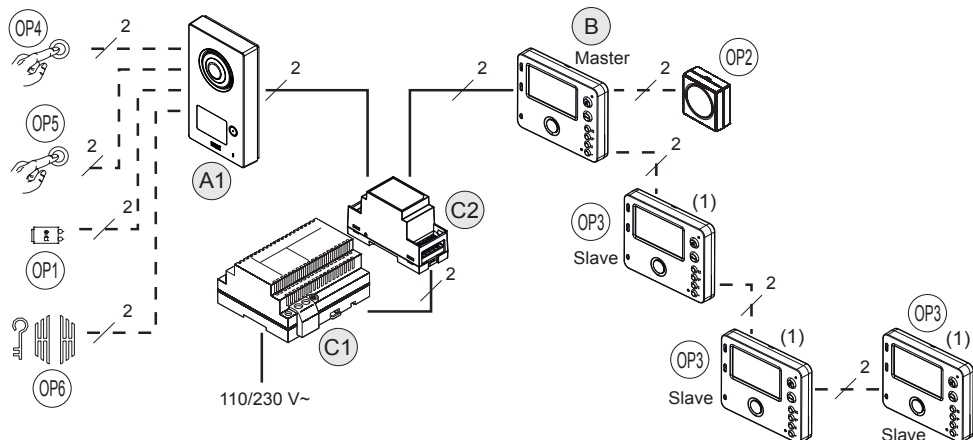

(1) For dip-switch configurations see par. 7.2 DIP-SWITCH CONFIGURATION

The OP2 supplementary ringer may be connected to any video door phone in the system.

5.1.1. MAXIMUM DISTANCES BETWEEN DEVICES

Basic system with 1 video door phone

Segment	Type of wire							
	2Voice cable	SYT1 (Ø 0,8 mm / AWG20)	CAT5/CAT6	Ø 0.6 mm / AWG22 Twisted telephone wire without sheath	0,5 mm ² / AWG20 single cable	0,75 mm ² / AWG18 single cable	1 mm ² / AWG17 single cable	1,5 mm ² / AWG15 single cable
A1 - most distant video door phone	150 m / 492 ft	130 m / 426 ft	80 m / 262 ft	100 m / 328 ft	60 m / 196 ft	100 m / 328 ft	100 m / 328 ft	100 m / 328 ft
C1 - C2	0,5 m / 1.6 ft	0,5 m / 1.6 ft	0,5 m / 1.6 ft	0,5 m / 1.6 ft	0,5 m / 1.6 ft	0,5 m / 1.6 ft	0,5 m / 1.6 ft	0,5 m / 1.6 ft
C2 - most distant video door phone	150 m / 492 ft	75 m / 246 ft	40 m / 131 ft	40 m / 131 ft	60 m / 196 ft	100 m / 328 ft	100 m / 328 ft	100 m / 328 ft
A1 - OP1	20 m / 65 ft	10 m / 32 ft *	10 m / 32 ft	10 m / 32 ft	10 m / 32 ft	10 m / 32 ft	20 m / 65 ft	20 m / 65 ft
A1 - OP4	50 m / 164 ft	50 m / 164 ft	30 m / 98 ft	50 m / 164 ft	50 m / 164 ft	50 m / 164 ft	50 m / 164 ft	50 m / 164 ft
A1 - OP5	20 m / 65 ft	10 m / 32 ft *	10 m / 32 ft	10 m / 32 ft	10 m / 32 ft	10 m / 32 ft	20 m / 65 ft	20 m / 65 ft
A1 - OP6	20 m / 65 ft	10 m / 32 ft *	10 m / 32 ft	10 m / 32 ft	10 m / 32 ft	10 m / 32 ft	20 m / 65 ft	20 m / 65 ft
B - OP2	30 m / 98 ft	30 m / 98 ft	10 m / 32 ft	30 m / 98 ft	30 m / 98 ft	30 m / 98 ft	30 m / 98 ft	30 m / 98 ft

(*) SYT1 wire contains two pairs of wires inside. Use both to reach a distance of 20 m / 65 ft.

System up to 4 video door phones

Segment	Type of wire							
	2Voice cable	SYT1 (Ø 0,8 mm / AWG20)	CAT5/CAT6	Ø 0.6 mm / AWG22 Twisted telephone wire without sheath	0,5 mm ² / AWG20 single cable	0,75 mm ² / AWG18 single cable	1 mm ² / AWG17 single cable	1,5 mm ² / AWG15 single cable
A1 - most distant video door phone	150 m / 492 ft	130 m / 426 ft	80 m / 262 ft	100 m / 328 ft	60 m / 196 ft	100 m / 328 ft	100 m / 328 ft	100 m / 328 ft
C1 - C2	0,5 m / 1.6 ft	0,5 m / 1.6 ft	0,5 m / 1.6 ft	0,5 m / 1.6 ft	0,5 m / 1.6 ft	0,5 m / 1.6 ft	0,5 m / 1.6 ft	0,5 m / 1.6 ft
C2 - most distant video door phone	150 m / 492 ft	75 m / 246 ft	40 m / 131 ft	40 m / 131 ft	60 m / 196 ft	100 m / 328 ft	100 m / 328 ft	100 m / 328 ft
A1 - OP1	20 m / 65 ft	10 m / 32 ft *	10 m / 32 ft	10 m / 32 ft	10 m / 32 ft	10 m / 32 ft	20 m / 65 ft	20 m / 65 ft
A1 - OP4	50 m / 164 ft	50 m / 164 ft	30 m / 98 ft	50 m / 164 ft	50 m / 164 ft	50 m / 164 ft	50 m / 164 ft	50 m / 164 ft
A1 - OP5	20 m / 65 ft	10 m / 32 ft *	10 m / 32 ft	10 m / 32 ft	10 m / 32 ft	10 m / 32 ft	20 m / 65 ft	20 m / 65 ft
A1 - OP6	20 m / 65 ft	10 m / 32 ft *	10 m / 32 ft	10 m / 32 ft	10 m / 32 ft	10 m / 32 ft	20 m / 65 ft	20 m / 65 ft
B - OP2	30 m / 98 ft	30 m / 98 ft	10 m / 32 ft	30 m / 98 ft	30 m / 98 ft	30 m / 98 ft	30 m / 98 ft	30 m / 98 ft

(*) SYT1 wire contains two pairs of wires inside. Use both to reach a distance of 20 m / 65 ft.

5.2. TWO-HOUSEHOLD SYSTEM

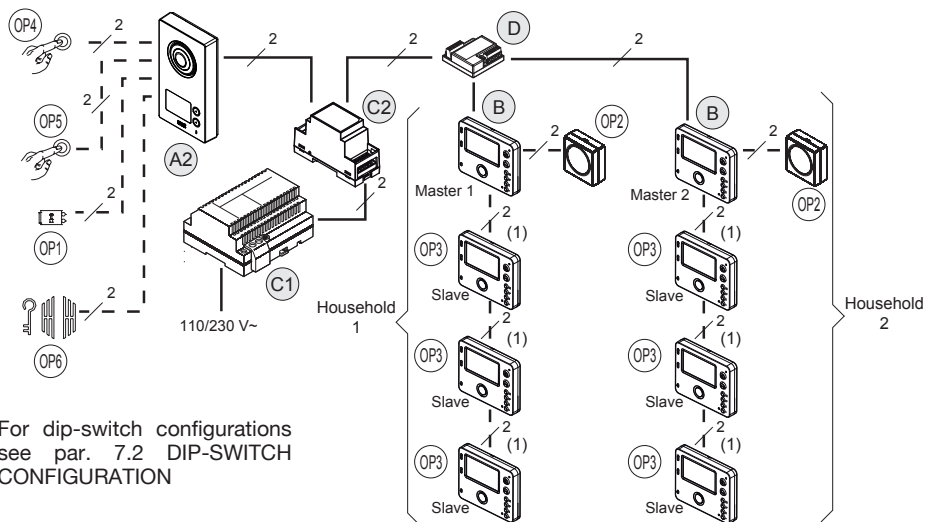

(1) For dip-switch configurations see par. 7.2 DIP-SWITCH CONFIGURATION

 The OP2 supplementary ringer may be connected to any video door phone in the system.

5.2.1. MAXIMUM DISTANCES BETWEEN DEVICES

Basic system with 2 video door phones and distributor

Segment	Type of wire								
	2Voice cable	SYT1 (Ø 0.8 mm / AWG20)	CAT5/CAT6	Ø 0.6 mm / AWG22 Twisted telephone wire without sheath	0.5 mm ² / AWG20 single cable	0.75 mm ² / AWG18 single cable	1 mm ² / AWG17 single cable	1.5 mm ² / AWG15 single cable	
A2 - most distant video door phone	150m / 492ft	130m / 426ft	60m / 196ft	100m / 328ft	60m / 196ft	100m / 328ft	100m / 328ft	100m / 328ft	
C2 - most distant video door phone	-	50m / 164ft	15m / 49ft	40m / 131ft	20m / 65ft	30m / 98ft	30m / 98ft	30m / 98ft	
D - most distant video door phone	50m / 164ft	-	-	-	-	-	-	-	
C1 - C2	0.5m / 1.6ft	0.5m / 1.6ft	0.5m / 1.6ft	0.5m / 1.6ft	0.5m / 1.6ft	0.5m / 1.6ft	0.5m / 1.6ft	0.5m / 1.6ft	
A2 - OP1	20m / 65ft	10m / 32ft *	10m / 32ft	10m / 32ft	10m / 32ft	10m / 32ft	20m / 65ft	20m / 65ft	
A2 - OP4	50m / 164ft	50m / 164ft	30m / 98ft	50m / 164ft	50m / 164ft	50m / 164ft	50m / 164ft	50m / 164ft	
A2 - OP5	20m / 65ft	10m / 32ft *	10m / 32ft	10m / 32ft	10m / 32ft	10m / 32ft	20m / 65ft	20m / 65ft	
A2 - OP6	20m / 65ft	10m / 32ft *	10m / 32ft	10m / 32ft	10m / 32ft	10m / 32ft	20m / 65ft	20m / 65ft	
B - OP2	30m / 98ft	30m / 98ft	10m / 32ft	30m / 98ft	30m / 98ft	30m / 98ft	30m / 98ft	30m / 98ft	

(*) SYT1 wire contains two pairs of wires inside. Use both to reach a distance of 20 m / 65 ft.

System up to 8 video door phones and distributor

Segment	Type of wire								
	2Voice cable	SYT1 (Ø 0.8 mm / AWG20)	CAT5/CAT6	Ø 0.6 mm / AWG22 Twisted telephone wire without sheath	0.5 mm ² / AWG20 single cable	0.75 mm ² / AWG18 single cable	1 mm ² / AWG17 single cable	1.5 mm ² / AWG15 single cable	
A2 - most distant video door phone	150m / 492ft	100m / 328ft	60m / 196ft	100m / 328ft	60m / 196ft	100m / 328ft	100m / 328ft	100m / 328ft	
C2 - most distant video door phone	-	40m / 131ft	15m / 49ft	15m / 49ft	-	-	-	-	
D - most distant video door phone	50m / 164ft	-	-	-	20m / 65ft	30m / 98ft	30m / 98ft	30m / 98ft	
C1 - C2	0.5m / 1.6ft	0.5m / 1.6ft	0.5m / 1.6ft	0.5m / 1.6ft	0.5m / 1.6ft	0.5m / 1.6ft	0.5m / 1.6ft	0.5m / 1.6ft	
A2 - OP1	20m / 65ft	10m / 32ft *	10m / 32ft	10m / 32ft	10m / 32ft	10m / 32ft	20m / 65ft	20m / 65ft	
A2 - OP4	50m / 164ft	50m / 164ft	30m / 98ft	50m / 164ft	50m / 164ft	50m / 164ft	50m / 164ft	50m / 164ft	
A2 - OP5	20m / 65ft	10m / 32ft *	10m / 32ft	10m / 32ft	10m / 32ft	10m / 32ft	20m / 65ft	20m / 65ft	
A2 - OP6	20m / 65ft	10m / 32ft *	10m / 32ft	10m / 32ft	10m / 32ft	10m / 32ft	20m / 65ft	20m / 65ft	
B - OP2	30m / 98ft	30m / 98ft	10m / 32ft	30m / 98ft	30m / 98ft	30m / 98ft	30m / 98ft	30m / 98ft	

(*) SYT1 wire contains two pairs of wires inside. Use both to reach a distance of 20 m / 65 ft.

6. WARNINGS FOR INSTALLERS

Read the notes in this manual carefully. This manual contains important information on safe installation, use and maintenance.

- This devices in the kit must only be put to the use for which they were intended. All other use is improper. The manufacturer cannot be held responsible for damage deriving from improper, incorrect or unreasonable use.
- Each part was designed to be compliant with the standards in force.
- The system must be built in compliance with the regulations in force. All devices in the system must be exclusively used for the purpose for which they were designed.
- Remove the components from the packaging and check that they are intact.
- Keep the packaging (plastic bags, polystyrene, etc.) away from children. Packaging is potentially dangerous.
- Provide a suitable cut-off and protection master switch upstream from the devices, with contacts open by at least 3 mm.
- Make sure that the plate data corresponds to the power specifications before connecting the devices to the mains.
- Keep the ventilation or cooling openings and slots free.
- Disconnect the devices from the mains before cleaning or maintenance.
- Do not use spray products to clean the device.
- Disconnect power from the circuit breaker in the event of failure and/or malfunctioning of the products contained in the kit. Do not tamper with the devices.
- Exclusively contact a service centre authorised by the manufacturer for repairs.
- Provide suitable ventilation.
- Do not use power extension wires.
- Have the device checked and repaired by qualified personnel in the case of infiltration of fluid or objects inside the device.
- Exclusively use the spare parts supplied by the manufacturer for repairs.
- Installers must make sure that user's information is applied to the connected devices.
- Disrespect of these precautions can effect safety of the devices.
- Keep this manual with the device at all times.
- The lightning symbol in a equilateral triangle indicates the presence of dangerous voltage.



- Never open the devices unless expressly instructed to do so in this instruction manual.
- The exclamation mark symbol in an equilateral triangle indicates critical safety components. Always only use components supplied by the manufacturer.



7. VIDEO DOOR PHONE INSTALLATION

Install flush-mounting box at the height indicated in the drawing below.
Fix the bracket to the mounting box or to the wall as indicated.
Program the dip switches.

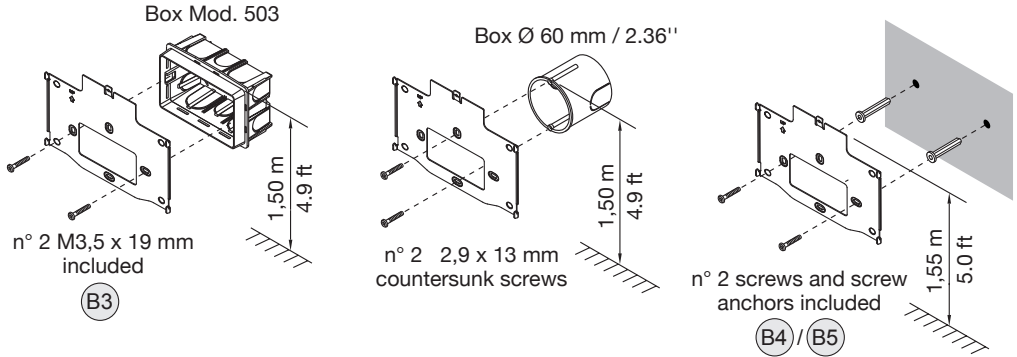

7.1. DESCRIPTION OF TERMINALS

- ⊗] LINE IN Bus Line input
- ⊗] LINE OUT Bus Line output
- ⊗ Z } Output for connecting supplementary ringers (OP2)
- ⊗ K }
- ⊗ X2 } Button ●●
- ⊗ X1 }
- ⊗ Y2 } Button ●●
- ⊗ Y1 }

7.2. DIP-SWITCH CONFIGURATION

7.2.1 Video door phone code

Set the respective address using the dip switches on each apartment station to install "Slave" video door phones.



Type of video door phone	Dip switch position	Type of video door phone	Dip switch position
"Master" video door phone		"Slave" 1 video door phone	
"Slave" 2 video door phone		"Slave" 3 video door phone	

7.2.2 Call button to video door phone association

	Dip switch position		Dip switch position
Video door phone associated with the call button 1		Video door phone associated with the call button 2	

7.2.3 Line terminal

The line termination must be activated on a video door phone connected at the end of a line without a new section restarting from the LINE OUT terminals.

	Dip switch position		Dip switch position
Terminal insert (default)		Terminal not inserted	

7.3. INSTALLATION COMPLETION

Connect.

Fix the video door phone to the bracket.

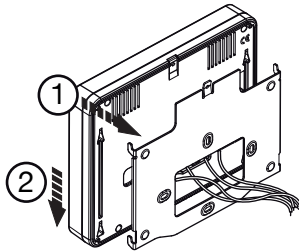

To remove the video door phone from the bracket, insert the tip of a screwdriver into the seating as indicated in the figure and push the video door phone upwards.

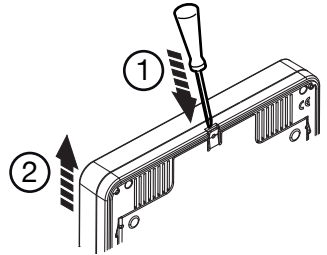

7.4. PROGRAMMING THE INTERCOM FUNCTION

The system offers the option of programming 2 buttons (1 ● and ●●) to make intercom calls.

With the kit Ref. 1722/93 you can call up to 2 video door phones in the same apartment.

With the kit Ref. 1722/94 you have two calling options:

- up to 2 video door phones in the same apartment,
- 1 video door phone in the same apartment and all video door phones of the other apartment.

To programme the buttons:

- Go to the indoor station to be programmed as caller (indoor station A).
- Press and hold ● for more than 5 seconds; the red LED will flash slowly and the system will emit 3 confirmation beeps to confirm the new setting.
- Press the button to be programmed as “caller” (● or ●●) for at least 3 seconds until you hear the confirmation tone.
- Go to the indoor station to be called by that button (indoor station B) and press the door-key button. The indoor stations A and B will emit a beep to confirm the new setting.
- To exit the programming mode, press and hold ● for more than 5 seconds on the indoor station A.



In any case, after 10 minutes the device will automatically quit the programming mode, saving the edited parameters.

With the kit Ref. 1722/94, the call to a video door phone in the second apartment will necessarily sound all video door phones in the apartment.

8. POWER SUPPLY UNIT INSTALLATION

Power supply in CAT II 2500 V. Once installed, the power supply is subject to transient voltages higher than those of the overvoltage category for which it was designed. For this reason, an additional transient voltage protection is required outside the device.

The power supply unit must be installed in the electric panel or a cabinet.

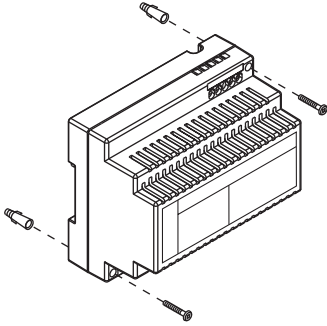

Wall-mounted installation

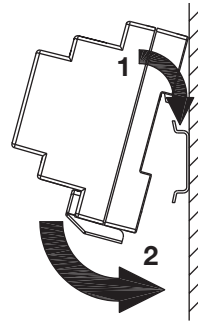

Installation on DIN bar
(6 modules, 18 mm / 0.71" each)

The electronic inductor unit module may be fixed to the wall by means of bracket supply in the kit or fixed to DIN bar (2 modules, 18 mm / 0.71" each).

The electronic inductor module must be installed in the same electric panel as the power supply unit.

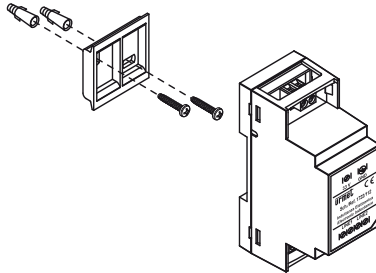

8.1. POWER SUPPLY CONNECTION

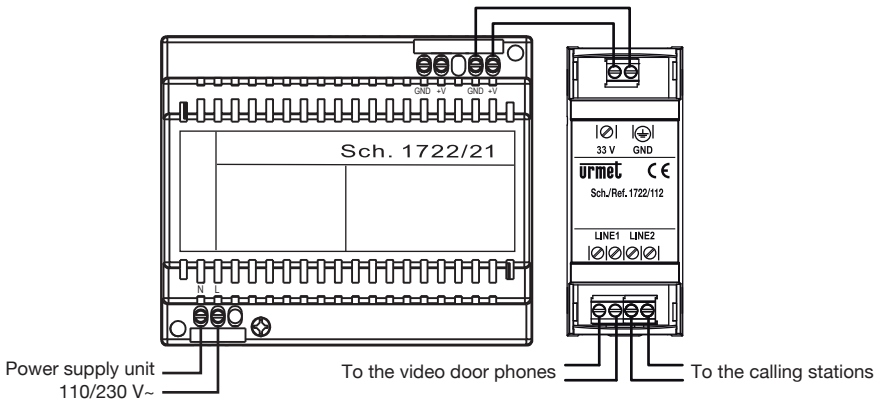

8.2. DESCRIPTION OF TERMINALS

Power supply unit Ref. 1722/21

- ⊙ N } Mains power voltage input 110/230 V~
- ⊙ L } Mains power voltage input 110/230 V~
- ⊙ GND } Power voltage output
- ⊙ 33V } Power voltage output

Electronic inductor module Ref. 1722/112

- ⊙ GND } Power voltage input
- ⊙ 33V } Power voltage input
- ⊙] LINE1 BUS line 1
- ⊙] LINE2 BUS line 2

9. CALLING STATION INSTALLATION

9.1. DESCRIPTION OF COMPONENTS

FRONT VIEW

Panel with 1 calling button
Ref. 1722/115
(Kit Ref. 1722/93)

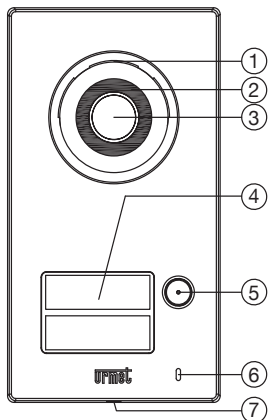

Panel with 2 calling buttons
Ref. 1722/116
(Kit Ref. 1722/94)

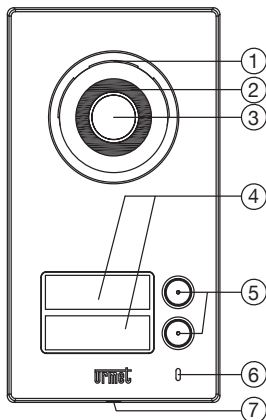

1. Speaker
2. Camera lighting LED
3. Camera
4. Name tag(s)
5. Calling button(s)
6. Microphone
7. Front closing screw

INSIDE

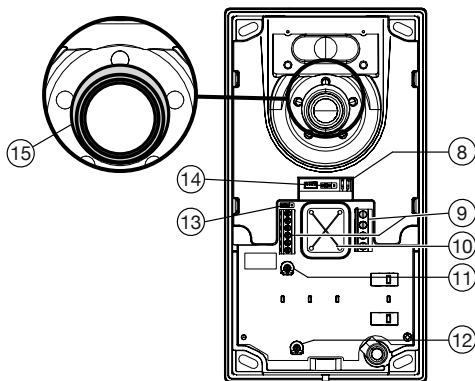

8. Dip-switch
9. Terminal boards
10. Hole for running wires
11. Speaker volume trimmer
12. **Do not turn this trimmer**
13. Jumper for turn ON the Led camera.
14. **Do not turn this Jumper**
15. Anti-reflection seal

9.2. INSTALLATION METOD

- Install the panel at the indicated heights checking that the caller is framed by the camera.
- Connect the wires to the terminal board.
- Fit the name tags on the removable front.
- Program.
- Adjust the sound level;
- Close the metal lid of the panel.
- Remove the protective films.

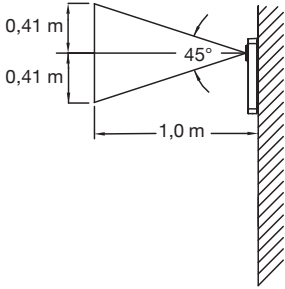

Vertical camera range

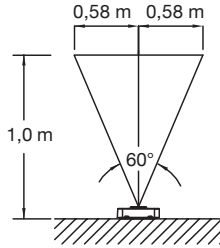

Horizontal camera range

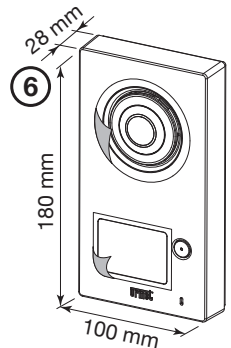
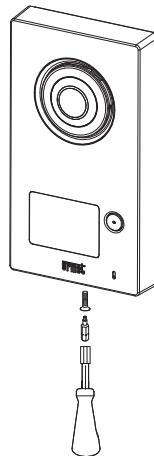
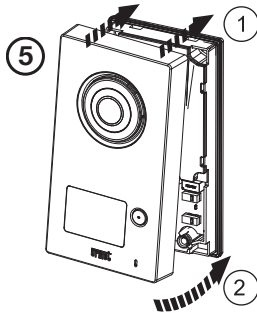
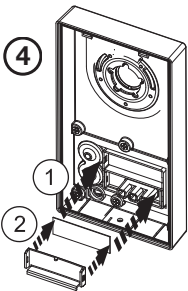
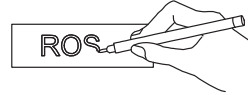
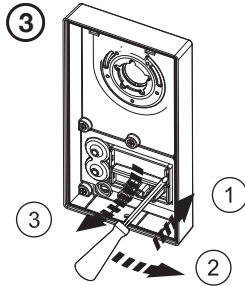
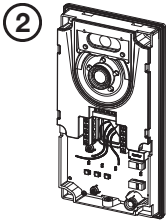
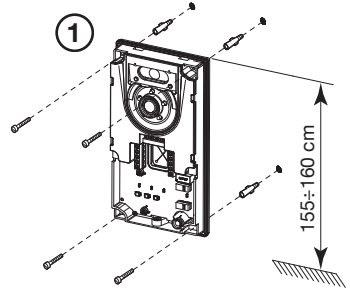

9.3. DESCRIPTION OF THE TERMINALS

- ⊘ } AP1 Hall button terminals for pedestrian electric lock (OP4)
- ⊘ } AP2 Hall button terminals for garage gate lock (OP5)
- ⊘ } C Garage gate opener operation dry contact (OP6) - maximum switch 1 A @ 30 V
- ⊘ } NO
- ⊘ } L
- ⊘ } L BUS line
- ⊘ } SE2 Pedestrian electric lock operation (OP1) - maximum switch 12 V~ 15 VA
- ⊘ } SE1

9.4. PEDESTRIAN GATE ELECTRIC LOCK ACTIVATION TIME SETTING

The pedestrian gate electric lock activation time can be adjusted using the dip switches present in the calling station:

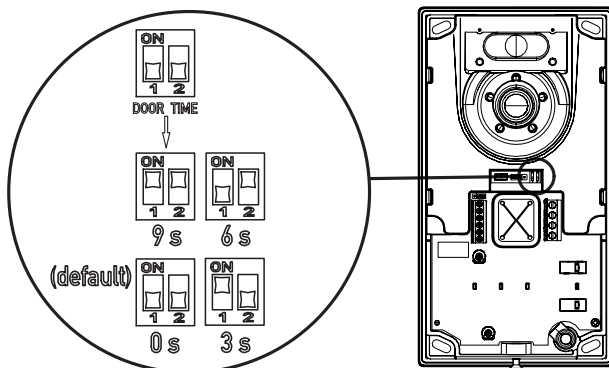

9.5. CAMERA LED ON / OFF ADJUSTMENT

The position of the jumper on the inside of the device can be used to select the turning ON or OFF the camera LED. During installation phases, the leds of the TV camera can be disabled. This operation must be carried out only if the call station is installed in an area where sufficient lighting is guaranteed during the day and night.

To de-activate the leds of the TV camera, operate on the jumper indicated in the figure.

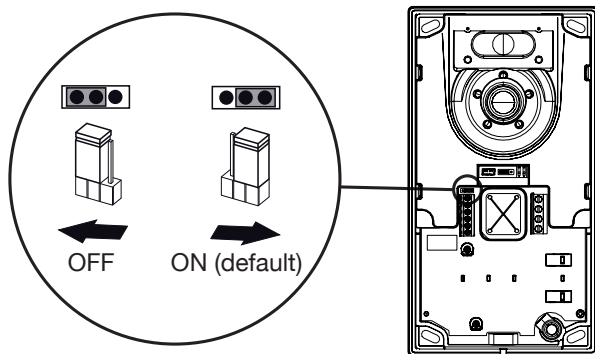

9.6. SPEAKER SOUND LEVEL ADJUSTMENT

Volumes are calibrated by default so not to require adjustments in most cases. Use a screwdriver to adjust the speaker volume, if required.

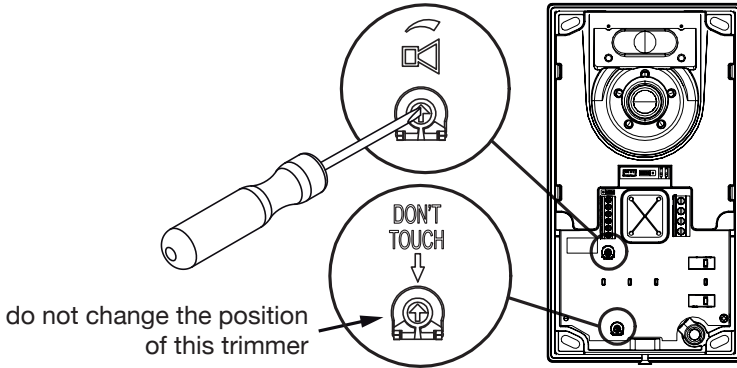

10. OPERATION



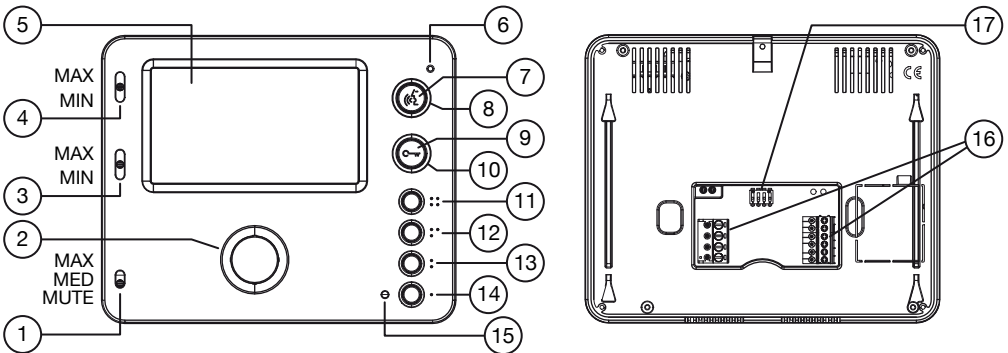

10.1. DESCRIPTION OF THE FRONT OF THE VIDEO DOOR PHONE

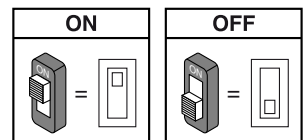
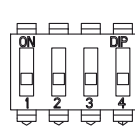

1. Call volume adjustment (MAX, MEDIUM; MUTE)
2. Call and conversation speaker
3. Display brightness adjustment
4. Display colour intensity adjustment
5. Display 4.3" format 16:9
6. Microphone
7. Button used to activate/deactivate audio
8. Red/green LED under the button
9. door opener button
10. Green LED under the button
11. Button to connect to Yokis devices; contacts Y1, Y2: max 50 mA @ 12 V $\overline{--}$
12. Button to connect to Yokis devices; contacts X1, X2: max 50 mA @ 12 V $\overline{--}$
13. Button : auto-on function
14. Button : garage gate door opener (OP6)
15. Red programming LED
16. Terminals for connecting to the system
17. Configuration dip switch:
 - n.1-2: video door phone code;
 - n.3: call button to video door phone association;
 - n.4: line terminal.





10.1.1 Button functions

State Button	STAND-BY	WAITING FOR PICK-UP (RECEIVING CALL)	DURING AUDIO OPERATION	STAND-BY AND BUTTON PRESSED	STATE OF PROGRAMMING* (ONLY WITH VIDEO DOOR PHONE IN STAND-BY).
	[Confirm association of intercom function between video door phones]	Open pedestrian door	Open pedestrian door	Open pedestrian door	---
	---	Audio activation	Pressing this key briefly will start or end the conversation	---	---
	Auto-on function	Video switching	---	Programmable intercom call 2 (Default: not programmed)	[Request association of intercom function between video door phones] (*)
	Access programming mode (if pressed for 5 seconds)	Garage gate door opener	Garage gate door opener	Programmable intercom call 1 (Default: not programmed)	Select video door phone call ringtone (5 different ringtones) / [Request association of intercom function between video door phones] (*)





(*) If pressed for at least 3 seconds until you hear the confirmation tone (see par. 7.4 PROGRAMMING THE INTERCOM FUNCTION)

10.1.2 Indicator LEDs

8. LED under the  button
 - Red: call in progress
 - Green: conversation ongoing
10. Green LED under the  button
 - On steady: possibility of a door opening
15. Red programming LED
 - On and flashing: programming mode enabled



10.2. CALL RECEPTION

The following events will occur when the calling button is pressed:

- The camera LEDs will light up.
- The name tag backlighting will go off for a time.
- The video door phones will emit the call tone.
- The video stream of the calling station camera will appear on the “Master” video door phone. The green  button and the red  button will light up.
- The green  button and the red  button will light up on the “Slave” video door phones.

 The video door phone will return to stand-by conditions if no button is pressed within three minutes from the call.





The following operations can be performed after a call on the “Master” video door phone:

- Press  to turn the audio on: after having turned audio on, the button will turn green and conversation with the caller is possible for up to 3 minutes (the conversation can be interrupted at any time by pressing .

 While the audio is on, the name tag backlighting LEDs of the call station will be turned off.

10.3. INTERCOM CALL MANAGEMENT

To make an intercom call:

- Press button , which will start blinking green;
- Press ● or ● to send the call to the video door phone with which you want to establish a conversation (see the procedure for programming the buttons under par. 7.4 PROGRAMMING THE INTERCOM FUNCTION);
- While waiting for a response, the LED of button  is lit red;
- When the video door phone called responds, the LED of button  remains lit green for the entire time of the conversation;
- Press button  to stop the conversation.

10.4. VIDEO SWITCHING

The call tone will be generated in alternating manner by the various video door phones after a call if “Slave” video door phones (OP3) are present in the system. The “Master” video door phone will enable monitor switch-on if the call is from a video calling station. In this case, during the call pick-up time (3 minutes from the call), the video door phones of the other devices can be switched on by pressing the auto-on button ● (video switching function) until one of the video door phones picks up.

The picture of the main camera will appear only on the device that picked up afterwards.

The camera picture will therefore be normally shown on only one apartment station at a time.



10.5. OPENING THE DOORS

During a call, during communication (audio on) or during auto-on it is possible to:

- activate the pedestrian gate electric lock by pressing ;
- activate the garage gate lock by pressing ●.

10.6. AUTO POWER-ON

Press ● to see the video stream of the calling station camera on the video door phone.

Auto-on is silent (audio is not turned on) and the calling station LEDs will be off. During auto-on, the video stream of the camera will appear on the video door phone monitor. The green  button and the red  button will light up.

To exit the auto-on function, press ● (in any case, after 3 minutes the device automatically switches off).

While the video door phone is displaying the images of the calling station, it is possible to:

- Turn the audio on to speak with the calling station by pressing B (the conversation can be interrupted at any time by pressing button .

 *The camera LEDs will light up when audio is turned on.*

10.7. CALL TONE MUTING

It is possible to adjust the call volume to the point of excluding the ring tone (Mute) by moving the sliding cursor (see section 10.1 DESCRIPTION OF THE FRONT OF THE VIDEO DOOR PHONE).

The mute state is indicated by a red signal visible in the upper part of the cursor.

 *If the cursor is set to MUTE during a call, the video module of the video door phone will turn on, and all acoustic signals (beeps) and any additional ringtones will be disabled.*

10.8. SUPPLEMENTARY RINGER

The video door phones are provided with a pair of terminals (K, Z) for connecting a supplementary ringer. This ringer is controlled when any call tone is generated.

10.9. VIDEO DOOR PHONE CALL TONE SELECTION

In systems with several video door phones, it may be useful to differentiate the call tone of the various devices.

- To access the call tone selection menu with the system in standby, press and hold ● for more than 5 seconds; the red LED will flash slowly and the system will emit 3 confirmation beeps to confirm the new setting.
- Press ● ;
- The video door phones will emit the call tone.
- Press ● to vary the tone;
- To exit the programming mode, press and hold ● until you hear 3 confirmation beeps and the Red programming LED stops flashing.

 In all cases, the device will quit programming mode and save any changes after 10 minutes.

11. TECHNICAL SPECIFICATIONS

Power supply unit

Power supply:	110-250 V~ 50-60 Hz
Power:	50 W max
Secondary output:	34,5 V $\overline{\text{---}}$ 0.6 A continuous (+0.6 A intermittent)
Dissipated power after 1 working hour:	Max 50 Wh (180 kJ)
Dimensions (LxDxH):	108 (6 DIN modules) x 90 x 61 mm 4.25 x 3.54 x 2.40"

Electric inductor

Dimensions (LxDxH):	36 (2 DIN modules) x 103 x 57 mm 1.42 x 4.06 x 2.24"
---------------------------	---

Video door phone







Power voltage:	34,5 V $\overline{\text{---}}$
Maximum consumption:	150 mA
Stand-by (basic configuration):	8 mA
Working power:	max 6 W
LCD:	4.3" backlit 16:9 colour screen
Screen size:	95 x 50 mm 3.74 x 1.97"
Resolution:	480H x 272V pixel
Switch-on delay:	2 s Max
Transmitting capsule:	electret microphone
Receiving capsule:	speaker 45 Ω
Working temperature range:	-5 \div +45 $^{\circ}\text{C}$ 23 \div 113 $^{\circ}\text{F}$
Max. humidity:	90% UR
Dimensions (LxDxH):	160 x 26 x 130 mm 6.30 x 1.02 x 5.12"

Calling station

Maximum consumption:	300 mA
Stand-by (basic configuration):	50 mA
Working power:	max 10.4 W
Dimensions (LxDxH):	100 x 180 x 28 mm
Name tag dimensions:	48 x 15 mm
Tag and button light:	White LEDs
Degree of protection of casings:	IP55
Degree of protection from mechanical shocks:	IK07
Working temperature range:	-10 \div +50 $^{\circ}\text{C}$
Max. humidity:	90% UR
Max C-NO contact capacity:	1 A @ 30 V
Max SE1-SE2 contact capacity:	12 V~ Max 15 VA

 Wires with cross-section area of 0.5 mm² or larger must comply with IEC 60332-1-2; wires with cross section area smaller than 0.5 mm² must comply with IEC 60332-2-2.

11.1. KEY TO SIMBOLS

Symbol	Description
	Direct input voltage
	Alternating input voltage
	Power supply fitted with double insulator
	See the installation manual of the device
	DANGER - Presence of dangerous voltages
	DANGER - Presence of safety-critical components

SOMMAIRE

1	DESCRIPTION GENERALE	43
2	COMPOSITION DU KIT	44
3	DISPOSITIFS AUXILIAIRES	45
4	PIÈCES DE RECHANGE	46
5	SYNOPTIQUE DE CONNEXION	47
5.1	Installation monofamille.....	47
5.1.1	Distances maximales entre les dispositifs	47
5.2	Installation bi-famille	48
5.2.1	Distances maximales entre les dispositifs	48
6	AVERTISSEMENTS POUR L'INSTALLATEUR	49
7	INSTALLATION DU MONITEUR	50
7.1	Description des bornes	50
7.2	Configuration commutateurs	50
7.2.1	Code du moniteur	50
7.2.2	Association bouton d'appel aux moniteurs	51
7.2.3	Terminaison de ligne.....	51
7.3	Fixation du moniteur	51
7.4	Programmation de la fonction intercommunication	51
8	INSTALLATION DE L'ALIMENTATION DU SYSTÈME.....	52
8.1	Raccordement de l'alimentation	52
8.2	Description des bornes	53
9	INSTALLATION DE LA PLAQUE DE RUE.....	54
9.1	Description des composants	54
9.2	Modalités d'installation	55
9.3	Description des bornes	56
9.4	Réglage de la temporisation ouvre-porte.....	56
9.5	Réglage activation / désactivation LED de la caméra.....	56
9.6	Réglage du niveau phonique du haut-parleur.....	57
10	FONCTIONNEMENT.....	57
10.1	Description de la façade du moniteur	57
10.1.1	Fonctions des touches	58
10.1.2	Signalisations par led	58
10.2	Réception de l'appel	58
10.3	Gestion de l'appel intercommunication	59
10.4	Transfert vidéo	59
10.5	Ouverture des portes	59
10.6	Surveillance	59
10.7	Coupure de la tonalité d'appel.....	59
10.8	Sonnerie additionnelle.....	60
10.9	Choix de la tonalité d'appel du moniteur	60
11	CARACTÉRISTIQUES TECHNIQUES	60
11.1	Légendes symboles	61
12	SCHÉMAS DE RACCORDEMENT.....	62
12.1	Branchement du kit monofamille Réf. 1722/93 avec 3 moniteurs en parallèle.....	62
12.2	Branchement du kit bi-famille Réf. 1722/94 avec 3 moniteurs en parallèle sur chaque utilisateur.....	63
12.2.1	Exemple de raccordement au kit d'une sonnerie à timbre pour la répétition de l'appel.....	64
12.2.2	Exemple de raccordement au kit de deux serrures électriques avec ouverture simultanée.....	64
12.2.3	Légendes schémas vidéoportiers	65
12.2.4	Notes liées aux schémas vidéoportiers	66
12.3	Raccordement d'un module E2BPP pour la centralisation de l'éclairage et des volets roulants au moniteur Miro	67

1. DESCRIPTION GENERALE

Les kits vidéoportiers Mod. 1722/93 et /94 se caractérisent par leur simplicité d'installation et grâce à l'utilisation de 2 fils seulement non polarisés pour l'interconnexion des différents dispositifs. Le système de vidéo possède les caractéristiques suivantes:

Systeme

- Kit vidéoportier monofamille (Réf.1722/93) et bi-famille (Réf.1722/94) couleur à fonction audio mains libres;
- Connexion de tous les dispositifs par 2 fils non polarisés;
- Possibilité de brancher l'alimentation sur tout poste de l'installation, entre poste d'appel et moniteur;
- Chaque utilisateur peut disposer d'un maximum de 4 moniteurs (1 "Maître" et 3 "Esclave") appelés en parallèle;
- Aucune alimentation locale n'est requise;
- Tous les dispositifs sont conformes aux directives CE en matière de compatibilité électromagnétique et à la Directive pour la basse tension;
- Le système est intrinsèquement protégé contre les interférences électromagnétiques du type rayonnement et décharge.

Plaque de rue

- Plaque de rue avec façade en zamac, antivandale et résistant à un usage en extérieur (IP55);
- Caméra de plaque de rue couleur, avec éclairage par leds du sujet;
- Porte-nom rétro-éclairé de couleur blanche;
- Confirmation d'envoi de l'appel par signal sonore et extinction des diodes de rétro-éclairage de l'étiquette.















Moniteur

- Moniteur mains-libres à écran couleur 4,3", format 16:9;
- Mode de conversation mains-libres;
- Sonneries d'appel sélectionnables par l'utilisateur (5 au choix);
- Volume d'appel réglable avec possibilité de coupure (fonction "mute").











Fonctions de base

- Activation de la serrure électrique par décharge capacitive et courant de maintien, avec temporisation de désactivation programmable;
- Activation depuis le moniteur d'un deuxième accès (entrée véhicules);
- Prédisposé pour le raccordement d'un bouton hall d'entrée pour l'activation locale de la serrure électrique;
- Prédisposition pour la connexion d'un bouton de sortie pour l'activation locale de l'ouvre-porte du portail des voitures;
- Fonction d'auto-insertion sur le poste d'appel;
- Possibilité de relier au moniteur Maître, pour la répétition de l'appel, une sonnerie supplémentaire.
- Appel Intercom entre moniteurs à l'intérieur du même appartement (fonction disponible sur les deux références de kits vidéo).
- Appel Intercom entre moniteurs d'appartements différents (fonction disponible uniquement sur kit Réf.1722/94).



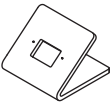

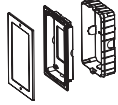



2. COMPOSITION DU KIT

	Description	Quantité	Identifiant dans la notice	
Plaque de rue (A)	Plaque modèle MIKRA2 avec 1 touche d'appel (uniquement dans le kit Réf. 1722/93)	1		A1
	Plaque modèle MIKRA2 avec 2 touches d'appel (uniquement dans le kit Réf. 1722/94)			A2
	Vis de fixation murale	4		A3
	Cheilles de fixation murale Ø 5mm (0.20")	4		A4
	Embout pour tournevis	1		A5
	Etiquette porte-nom (en quantité de 1 dans le kit Réf.1722/93, en quantité de 2 dans le kit Réf.1722/94)	1		A6
	Vis à six pans pour la fermeture de la plaque de rue	1		A7
Moniteur (B)	Moniteur Mod. Miro «Maître» (en quantité de 1 dans le kit Réf.1722/93, en quantité de 2 dans le kit Réf.1722/94)	1/2		B1
	Etrier de fixation murale (en quantité de 1 dans le kit Réf.1722/93, en quantité de 2 dans le kit Réf.1722/94)	1/2		B2
	Vis de fixation sur boîtier encastrable (en quantité de 2 dans le kit Réf.1722/93, en quantité de 4 dans le kit Réf.1722/94)	2/4		B3
	Vis de fixation murale (en quantité de 2 dans le kit Réf.1722/93, en quantité de 4 dans le kit Réf.1722/94)	2/4		B4
	Cheilles de fixation murale Ø 5mm (0.20") (en quantité de 2 dans le kit Réf.1722/93, en quantité de 4 dans le kit Réf.1722/94)	2/4		B5
Alimentation (C)	Alimentation vidéo dédiée pour le kit	1		C1
	Adaptateur bus 2 fils	1		C2
	Distributeur vidéo (uniquement avec le kit Réf.1722/94)	1		D

3. DISPOSITIFS AUXILIAIRES

Description		Nombre (en cas de configuration maximale de l'installation)	Identifiant dans la notice	
Serrure électrique (12V~ Max 15VA)		1		OP1
Sonnerie supplémentaire filaire	Réf.9854/43	1		OP2
Moniteur supplémentaire Mod. Miro « Esclave » (3 avec le kit Réf. 1722/93, 6 avec le kit Réf. 1722/94)	Réf.1722/88	3/6		OP3
Bouton de sortie pour activer la serrure électrique		1		OP4
Bouton de sortie pour activer l'ouverture du portail		1		OP5
Dispositif d'activation ouvre-porte d'accès véhicules (courant maxi commutable 1 A @ 30 V---)		1		OP6
Support de table pour moniteur (4 avec le kit Réf. 1722/93, 8 avec le kit Réf. 1722/94)	Réf.1750/52	4/8 (un pour chaque moniteur)		OP7
Boîtier à encastrer pour moniteur (4 avec le kit Réf. 1722/93, 8 avec le kit Réf. 1722/94)	Réf.1750/60	4/8 (un pour chaque moniteur)		OP8
Kit d'encastrement pour plaque de rue mod. Mikra2	Réf.1723/50	1		OP9
Interphones supplémentaire Mod. Miro « Esclave » (3 avec le kit Réf. 1722/93, 6 avec le kit Réf. 1722/94)	Réf.1122/4	3/6		OP10
Distributeur vidéo (uniquement avec le kit Réf.1722/94)	Réf.1722/55	1		D

4. PIÈCES DE RECHANGE

Description			Identifiant dans la notice
Plaque modèle MIKRA2 avec 1 touche d'appel (uniquement dans le kit Réf. 1722/93)	Réf.1722/115		A1
Plaque modèle MIKRA2 avec 2 touches d'appel (uniquement dans le kit Réf. 1722/94)	Réf.1722/116		A2
Adaptateur bus 2 fils	Réf.1722/112		C2
Alimentation	Réf.1722/21		C1
Bouton de rechange pour plaque de rue bi-famille	Réf.1722/114		A8
Moniteur Miro Maître/Esclave	Réf.1722/88		B/OP3
Interphone Miro « Esclave »	Réf. 1122/4		OP10
Distributeur vidéo (uniquement avec le kit Réf.1722/94)	Réf.1722/55		D

5. SYNOPTIQUE DE CONNEXION

5.1. INSTALLATION MONOFAMILLE

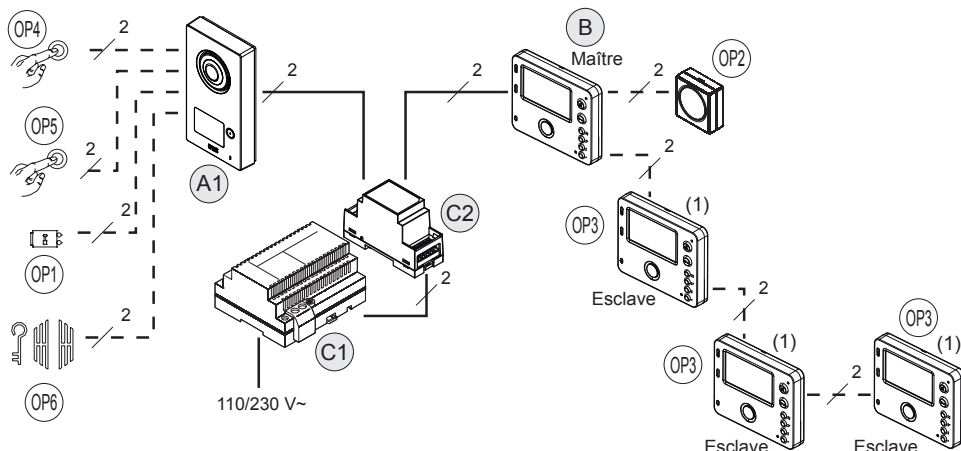

(1) Pour la configuration des commutateurs, voir par. 7.2 CONFIGURATION COMMUTATEUR.

 La sonnerie supplémentaire OP2 peut être indifféremment raccordée à n'importe quel moniteur de l'installation.

5.1.1. DISTANCES MAXIMALES ENTRE LES DISPOSITIFS

Installation de base avec 1 moniteur

Liaison	Type de câble							
	Câble 2Voice	SYT1 (Ø 0,8 mm / AWG20)	CAT5/CAT6	Câble téléphonique Ø 0,6 mm / AWG22 sans gaine	Câble 0,5 mm ² / AWG20 simple	Câble 0,75 mm ² / AWG18 simple	Câble 1 mm ² / AWG17 simple	Câble 1,5 mm ² / AWG15 simple
A1 – le moniteur le plus loin	150m / 492ft	130m / 426ft	80m / 262 ft	100m / 328ft	60m / 196ft	100m / 328ft	100m / 328ft	100 m / 328 ft
C1 – C2	0,5m / 1.6ft	0,5m / 1.6ft	0,5m / 1.6ft	0,5m / 1.6ft	0,5m / 1.6ft	0,5m / 1.6ft	0,5m / 1.6ft	0,5m / 1.6ft
C2 – le moniteur le plus loin	150m / 492ft	75m / 246ft	40m / 131ft	40m / 131ft	60m / 196ft	100m / 328ft	100m / 328ft	100m / 328ft
A1 – OP1	20m / 65ft	10m / 32ft*	10m / 32ft	10m / 32ft	10m / 32ft	10m / 32ft	20m / 65ft	20m / 65ft
A1 – OP4	50m / 164ft	50m / 164ft	30m / 98ft	50m / 164ft	50m / 164ft	50m / 164ft	50m / 164ft	50m / 164ft
A1 – OP5	20m / 65ft	10m / 32ft*	10m / 32ft	10m / 32ft	10m / 32ft	10m / 32ft	20m / 65ft	20m / 65ft
A1 – OP6	20m / 65ft	10m / 32ft*	10m / 32ft	10m / 32ft	10m / 32ft	10m / 32ft	20m / 65ft	20m / 65ft
B – OP2	30m / 98ft	30m / 98ft	10m / 32ft	30m / 98ft	30m / 98ft	30m / 98ft	30m / 98ft	30m / 98ft

(*) Le câble SYT1 contient plusieurs paires; en doublant les paires il est possible de doubler la distance.

Installation avec 4 moniteurs

Liaison	Type de câble							
	Câble 2Voice	SYT1 (Ø 0,8 mm / AWG20)	CAT5/CAT6	Câble téléphonique Ø 0,6 mm / AWG22 sans gaine	Câble 0,5 mm ² / AWG20 simple	Câble 0,75 mm ² / AWG18 simple	Câble 1 mm ² / AWG17 simple	Câble 1,5 mm ² / AWG15 simple
A1 – le moniteur le plus loin	150m / 492ft	130m / 426ft	80m / 262ft	100m / 328ft	60m / 196ft	100m / 328ft	100m / 328ft	100m / 328ft
C1 – C2	0,5m / 1.6ft	0,5m / 1.6ft	0,5m / 1.6ft	0,5m / 1.6ft	0,5m / 1.6ft	0,5m / 1.6ft	0,5m / 1.6ft	0,5m / 1.6ft
C2 – le moniteur le plus loin	150m / 492ft	75m / 246ft	40m / 131ft	40m / 131ft	60m / 196ft	100m / 328ft	100m / 328ft	100m / 328ft
A1 – OP1	20m / 65ft	10m / 32ft*	10m / 32ft	10m / 32ft	10m / 32ft	10m / 32ft	20m / 65ft	20m / 65ft
A1 – OP4	50m / 164ft	50m / 164ft	30m / 98ft	50m / 164ft	50m / 164ft	50m / 164ft	50m / 164ft	50m / 164ft
A1 – OP5	20m / 65ft	10m / 32ft*	10m / 32ft	10m / 32ft	10m / 32ft	10m / 32ft	20m / 65ft	20m / 65ft
A1 – OP6	20m / 65ft	10m / 32ft*	10m / 32ft	10m / 32ft	10m / 32ft	10m / 32ft	20m / 65ft	20m / 65ft
B – OP2	30m / 98ft	30m / 98ft	10m / 32ft	30m / 98ft	30m / 98ft	30m / 98ft	30m / 98ft	30m / 98ft

(*) Le câble SYT1 contient plusieurs paires; en doublant les paires il est possible de doubler la distance.

5.2. INSTALLATION BI-FAMILLE

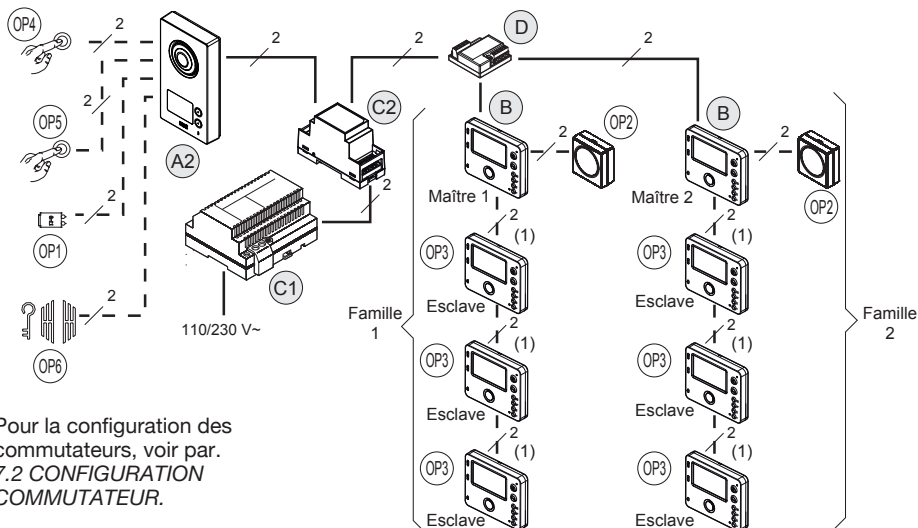

- (1) Pour la configuration des commutateurs, voir par 7.2 CONFIGURATION COMMUTATEUR.

 La sonnerie supplémentaire OP2 peut être indifféremment raccordée à n'importe quel moniteur de l'installation.

5.2.1. DISTANCES MAXIMALES ENTRE LES DISPOSITIFS

Installation de base avec 2 moniteurs et distributeur

Liaison	Type de câble							
	Câble 2Voice	SYT1 (Ø 0,8 mm / AWG20)	CAT5/CAT6	Câble téléphonique Ø 0,6 mm / AWG22 sans gaine	Câble 0,5 mm ² / AWG20 simple	Câble 0,75 mm ² / AWG18 simple	Câble 1 mm ² / AWG17 simple	Câble 1,5 mm ² / AWG15 simple
A2 – le moniteur le plus loin	150m / 492ft	130m / 426ft	60m / 196ft	100m / 328ft	60m / 196ft	100m / 328ft	100m / 328ft	100m / 328ft
C2 – le moniteur le plus loin	-	50m / 164ft	15m / 49ft	40m / 131ft	20m / 65ft	30m / 98ft	30m / 98ft	30m / 98ft
D – le moniteur le plus loin	50m / 164ft	-	-	-	-	-	-	-
C1 – C2	0,5m / 1,6ft	0,5 m / 1,6ft	0,5m / 1,6ft	0,5m / 1,6ft	0,5m / 1,6ft	0,5m / 1,6ft	0,5m / 1,6ft	0,5m / 1,6ft
A2 – OP1	20m / 65ft	10m / 32ft *	10m / 32ft	10m / 32ft	10m / 32ft	10m / 32ft	20m / 65ft	20m / 65ft
A2 – OP4	50m / 164ft	50m / 164ft	30m / 98ft	50m / 164ft	50m / 164ft	50m / 164ft	50m / 164ft	50m / 164ft
A2 – OP5	20m / 65ft	10m / 32ft *	10m / 32ft	10m / 32ft	10m / 32ft	10m / 32ft	20m / 65ft	20m / 65ft
A2 – OP6	20m / 65ft	10m / 32ft *	10m / 32ft	10m / 32ft	10m / 32ft	10m / 32ft	20m / 65ft	20m / 65ft
B – OP2	30m / 98ft	30m / 98ft	10m / 32ft	30m / 98ft	30m / 98ft	30m / 98ft	30m / 98ft	30m / 98ft

(*) Le câble SYT1 contient plusieurs paires; en doublant les paires il est possible de doubler la distance.

Installation avec 8 moniteurs et distributeur

Liaison	Type de câble							
	Câble 2Voice	SYT1 (Ø 0,8 mm / AWG20)	CAT5/CAT6	Câble téléphonique Ø 0,6 mm / AWG22 sans gaine	Câble 0,5 mm ² / AWG20 simple	Câble 0,75 mm ² / AWG18 simple	Câble 1 mm ² / AWG17 simple	Câble 1,5 mm ² / AWG15 simple
A2 – le moniteur le plus loin	150m / 492ft	100m / 328ft	60m / 196ft	100m / 328ft	60m / 196ft	100m / 328ft	100m / 328ft	100m / 328ft
C2 – le moniteur le plus loin	-	40m / 131ft	15m / 49ft	15m / 49ft	-	-	-	-
D – le moniteur le plus loin	50m / 164ft	-	-	-	20m / 65ft	30m / 98ft	30m / 98ft	30m / 98ft
C1 – C2	0,5m / 1,6ft	0,5m / 1,6ft	0,5m / 1,6ft	0,5m / 1,6ft	0,5m / 1,6ft	0,5m / 1,6ft	0,5m / 1,6ft	0,5m / 1,6ft
A2 – OP1	20m / 65ft	10m / 32ft *	10m / 32ft	10m / 32ft	10m / 32ft	10m / 32ft	20m / 65ft	20m / 65ft
A2 – OP4	50m / 164ft	50m / 164ft	30m / 98ft	50m / 164ft	50m / 164ft	50m / 164ft	50m / 164ft	50m / 164ft
A2 – OP5	20m / 65ft	10m / 32ft *	10m / 32ft	10m / 32ft	10m / 32ft	10m / 32ft	20m / 65ft	20m / 65ft
A2 – OP6	20m / 65ft	10m / 32ft *	10m / 32ft	10m / 32ft	10m / 32ft	10m / 32ft	20m / 65ft	20m / 65ft
B – OP2	30m / 98ft	30m / 98ft	10m / 32ft	30m / 98ft	30m / 98ft	30m / 98ft	30m / 98ft	30m / 98ft

(*) Le câble SYT1 contient plusieurs paires; en doublant les paires il est possible de doubler la distance.

6. AVERTISSEMENTS POUR L'INSTALLATEUR

Lire attentivement les instructions contenues dans le présent document, car elles fournissent d'importantes indications pour la sécurité d'installation, d'utilisation et d'entretien.

- Les dispositifs inclus dans le kit doivent être exclusivement destinés à l'utilisation pour laquelle ils ont été expressément conçus. Toute autre utilisation doit être considérée comme étant inappropriée. Le Constructeur ne saurait être tenu pour responsable des éventuels dommages résultant d'utilisations inappropriées ou illégitimes.
- Chaque élément a été étudié conformément aux normes en vigueur.
- L'exécution de l'installation doit être conforme aux normes en vigueur. Tous les appareils constituant l'installation doivent être exclusivement destinés à l'utilisation pour laquelle ils ont été conçus.
- Après avoir sorti les différents composants de leur emballage, s'assurer de leur état intact.
- Les éléments d'emballage (sacs en plastique, polystyrène expansé, etc.) doivent être mis hors de la portée des enfants, car ils représentent des sources potentielles de danger.
- Prévoir, en amont des appareils, un interrupteur approprié de sectionnement et protection, avec une distance d'ouverture des contacts d'au moins 3 mm.
- Avant de brancher les dispositifs d'alimentation, vérifier que les paramètres indiqués sur la plaque signalétique correspondent bien à ceux de l'alimentation secteur.
- Ne jamais obstruer les orifices ou les fentes de ventilation ou de dispersion de la chaleur.
- Avant d'exécuter toute opération de nettoyage ou d'entretien, mettre les dispositifs hors tension, en désactivant l'interrupteur général de l'installation.
- Ne pas utiliser de produits de nettoyage en spray.
- En cas de panne et/ou de dysfonctionnement des produits inclus dans le kit, couper l'alimentation électrique à l'aide de l'interrupteur général, sans endommager ni manipuler l'appareil.
- Pour toute réparation, contacter le service après-vente agréé par le Constructeur.
- Assurer une bonne ventilation.
- Ne pas utiliser de rallonges pour le câble d'alimentation.
- En cas d'infiltration de liquides ou en présence de corps étrangers dans l'appareil, s'adresser à un personnel qualifié pour les opérations de contrôle ou de réparation.
- Pour les réparations, utiliser exclusivement des pièces de rechange d'origine.
- L'installateur devra vérifier que les informations à l'attention de l'utilisateur sont bien présentes sur les appareils dérivés.
- Le non-respect des prescriptions précédentes peut compromettre la sécurité de l'installation.
- Le présent document doit toujours accompagner l'appareil.
- Le pictogramme de la foudre avec une flèche à l'intérieur d'un triangle équilatéral signale la présence de tensions dangereuses.



- Ne pas ouvrir les dispositifs, à moins que cela ne soit expressément prescrit dans la présente notice.
- Le pictogramme du point d'exclamation à l'intérieur d'un triangle équilatéral désigne des composants critiques pour la sécurité; n'utiliser que les composants fournis par le Constructeur.



7. INSTALLATION DU MONITEUR

Encastrer le boîtier à la hauteur indiquée dans la figure suivante.
Fixer l'étrier au boîtier encastrable ou à la paroi, comme indiqué.
Régler les commutateurs de programmation.

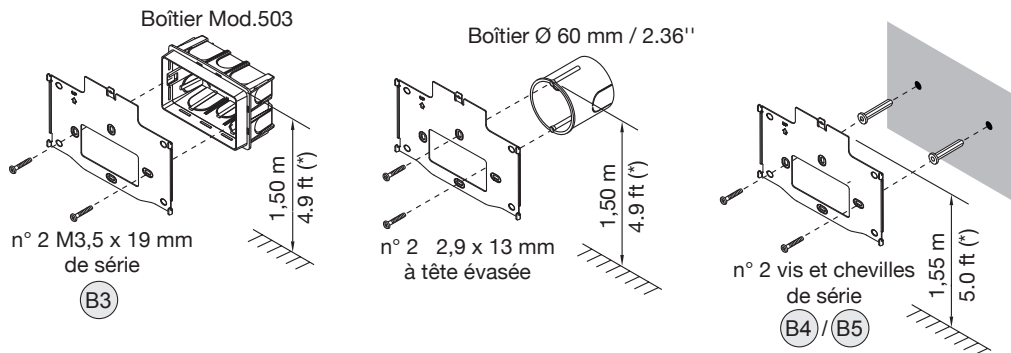

(*) Pour garantir le respect de la Directive de référence pour les personnes handicapées (par exemple, en France, voir la Loi 2005-102 du 11/02/2005, le Décret 2006-555 du 17/05/2006 et ses amendements ultérieurs des 1/08/2006, 26/02/2007 et 21/03/2007), l'écran du moniteur devra être mis en place à une hauteur comprise entre 0,90 et 1,30 m (2.95 ÷ 4.27 ft).

7.1. DESCRIPTION DES BORNES

- ⊙] LINE IN Arrivée Ligne Bus
- ⊙] LINE OUT Sortie Ligne Bus
- ⊙ Z } Sortie pour le raccordement de sonneries supplémentaires (OP2)
- ⊙ K }
- ⊙ X2 } Touche ●●
- ⊙ X1 }
- ⊙ Y2 } Touche ●●
- ⊙ Y1 }



7.2. CONFIGURATION COMMUTATEURS

7.2.1 Code du moniteur

Si on veut installer des moniteurs secondaires («Esclave»), il faut configurer l'adresse sur chaque poste interne avec les commutateurs.



Type de moniteur	Position des commutateurs	Type de moniteur	Position des commutateurs
Moniteur «Maître»		Moniteur «Esclave» n° 1	
Moniteur «Esclave» n° 2		Moniteur «Esclave» n° 3	

7.2.2 Association bouton d'appel aux moniteurs

	Position des commutateurs		Position des commutateurs
Moniteur associé au bouton d'appel 1		Moniteur associé au bouton d'appel 2	

7.2.3 Terminaison de ligne

Il est nécessaire d'activer la terminaison de ligne sur le moniteur branché à la fin d'une ligne ne repartant pas par une nouvelle section des bornes LINE OUT.

	Position des commutateurs		Position des commutateurs
Terminaison activée (par défaut)		Terminaison non activée	

7.3. FIXATION DU MONITEUR

Réaliser les branchements.
Fixer le moniteur à l'étrier.

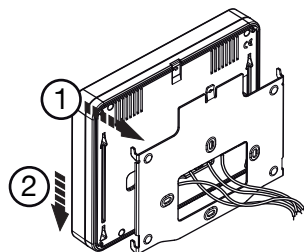

 Pour déposer le moniteur de l'étrier, introduire la pointe d'un tournevis dans le logement (voir figure) et pousser le moniteur vers le haut.

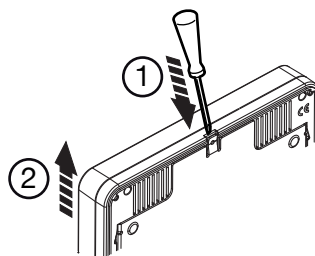

7.4. PROGRAMMATION DE LA FONCTION INTERCOMMUNICATION

Il est possible de programmer 2 boutons (● et ●) pour effectuer les appels d'intercommunication. Avec le kit réf. 1722/93, il est possible d'appeler 2 moniteurs dans le même appartement. Avec le kit réf. 1722/94, comme alternative, il est possible d'appeler:

- 2 moniteurs dans le même appartement,
- 1 moniteur dans le même appartement et tous les moniteurs de l'autre appartement.

La programmation est la suivante:

- Se rendre auprès du poste interne à programmer comme appelant (poste interne A).
- Maintenir enfoncée la touche ● pendant plus de 5 secondes; la confirmation de l'accès à la programmation est donnée par le clignotement de la led rouge et par l'émission de 3 bips de confirmation.
- Appuyer sur le bouton à programmer comme « appelant » (● ou ●) pendant au moins 3 secondes jusqu'au signal sonore de confirmation.
- Se rendre auprès du poste interne qui devra être appelé depuis cette touche (poste interne B) et appuyer sur le bouton d'ouverture de la porte. Les postes internes A et B émettent un bip de confirmation de la programmation.
- Pour quitter la programmation, maintenir enfoncée la touche ● pendant plus de 5 secondes sur le poste interne A.

 Dans tous les cas, au bout de 10 minutes, le dispositif quitte la programmation et sauvegarde les paramètres modifiés.

Avec le kit réf. 1722/94, l'appel d'un moniteur du deuxième appartement, fait nécessairement sonner tous les moniteurs présents dans l'appartement.

8. INSTALLATION DE L'ALIMENTATION

Alimentation en CAT II 2500 V. L'alimentateur, qui une fois installé peut subir des tensions transitoires supérieures à celles de la catégorie de surtension de projet, nécessite une protection supplémentaire des tensions transitoires externes à l'équipement.

Le dispositif doit être installé à l'intérieur d'un tableau ou d'une armoire électrique.

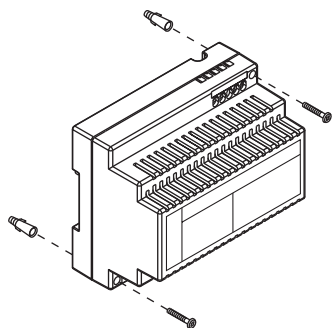

Installation murale en apparent

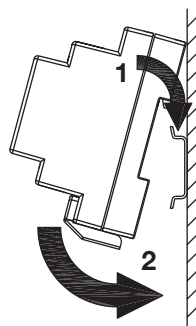

Installation sur rail DIN
(6 modules de 18 mm / 0.71")

Le module adaptateur bus 2 fils peut être installé à la paroi en utilisant l'étrier livré ou fixé sur rail DIN (2 modules 18mm / 0.71").

Le module adaptateur bus 2 fils doit être installé dans la même armoire électrique qui accueille l'alimentation.

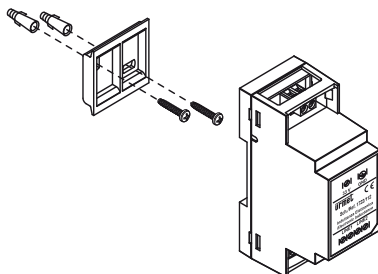

8.1. RACCORDEMENT DE L'ALIMENTATION

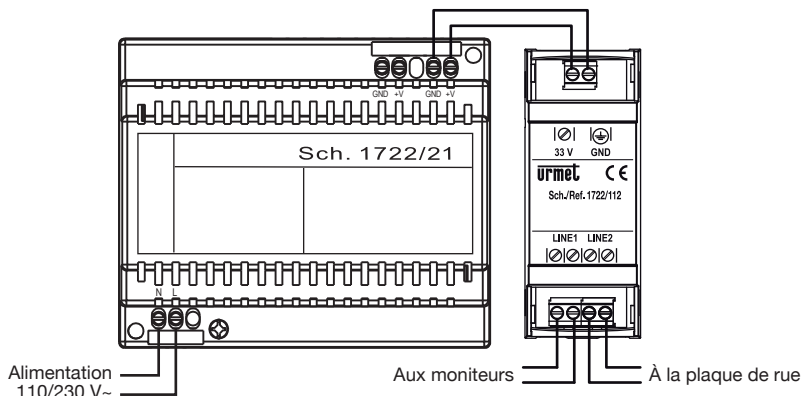

8.2. DESCRIPTION DES BORNES

Alimentation Réf. 1722/21

- ⊗] N
 - ⊗] L
 - ⊗ GND } Sortie tension d'alimentation
 - ⊗ +V }
- Entrée tension d'alimentation secteur 110/230 V~

Adaptateur bus 2 fils Réf. 1722/112

- ⊗ GND } Entrée tension d'alimentation
- ⊗ 33V }
- ⊗] LINE1 Ligne BUS 1
- ⊗] LINE2 Ligne BUS 2

9. INSTALLATION DE LA PLAQUE DE RUE

9.1. DESCRIPTION DES COMPOSANTS

FAÇADE

Plaque de rue avec 1 touche
d'appel Réf. 1722/115
(Kit Réf. 1722/93)

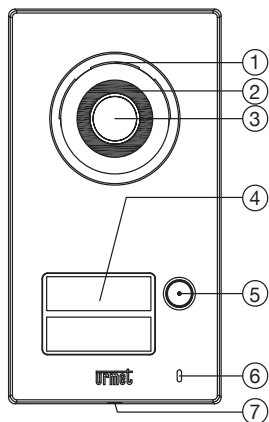

Plaque de rue avec 2 touches
d'appel Réf. 1722/116
(Kit Réf. 1722/94)

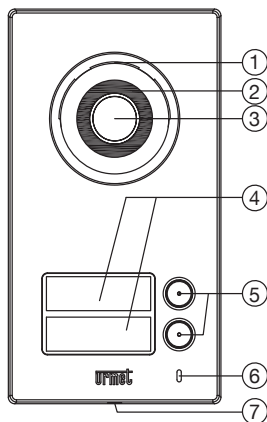

1. Haut-parleur
2. Diode d'éclairage caméra
3. Caméra
4. Etiquette(s) de nom
5. Bouton(s) d'appel
6. Microphone
7. Vis de fermeture façade

PARTIE INTÉRIEURE

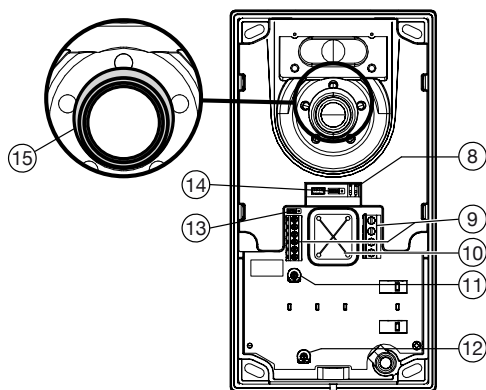

8. Switch rotatif
9. Borniers
10. Orifice pour le passage des câbles
11. Sélecteur de réglage du niveau phonique du haut-parleur
12. **Ne pas tourner ce sélecteur**
13. Cavalier pour allumer la LED de la caméra
14. **Ne pas tourner ce Cavalier**
15. Joint antireflet

9.2. MODALITES D'INSTALLATION

- Installer la plaque de rue à la hauteur indiquée vérifier que le sujet rentre dans le champ encadré par la caméra;
- Brancher les fils sur les borniers;
- Installer les étiquettes des noms sur la façade;
- Effectuer les programmations.
- Régler le niveau phonique.
- Refermer la plaque de rue à l'aide de son couvercle métallique.
- Retirer les films de protection.

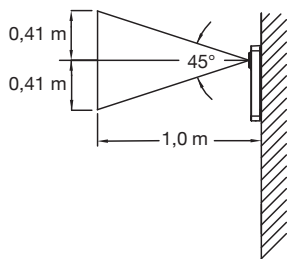

Angle de vue vertical

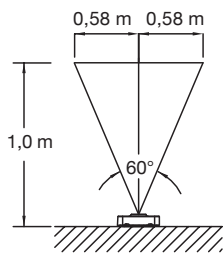

Angle de vue horizontal

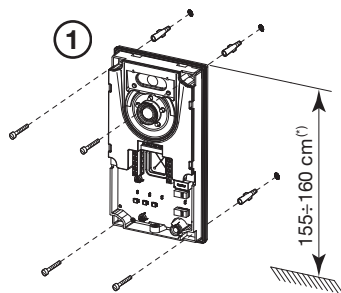

(*) Respecter une hauteur de pose de 1,30 m pour se conformer à la Directive de référence pour les personnes handicapées (par exemple, en France, voir la Loi 2005-102 du 11/02/2005, le Décret 2006-555 du 17/05/2006 et ses amendements ultérieurs des 1/08/2006, 26/02/2007 et 21/03/2007).

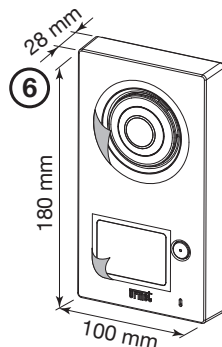
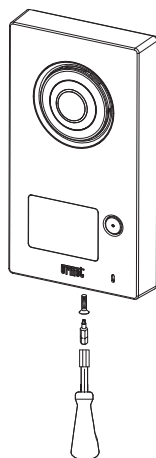
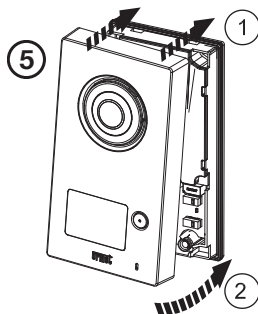
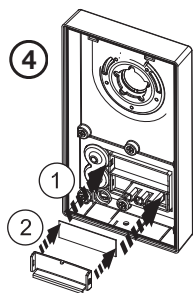
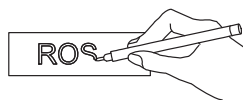
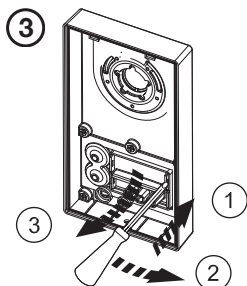
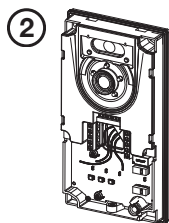

9.3. DESCRIPTION DES BORNES

⊘] AP1	Bornes pour bouton de sortie pour serrure électrique piétonne (OP4)
⊘		
⊘] AP2	Bornes pour bouton de sortie pour ouverture portail (OP5)
⊘		
⊘	} Contact sec de commande d'accès véhicules (OP7) – commutation maximale 1A @ 30V	
⊘		
⊘	} Ligne BUS	
⊘		
⊘	} Commande de serrure électrique (OP1) – commutation maximale 12V~ 15VA	
⊘		

9.4. RÉGLAGE DE LA TEMPORISATION OUVRE-PORTE

Le délai d'activation de la serrure électrique peut être réglé à l'aide des commutateurs prévus dans le poste d'appel:

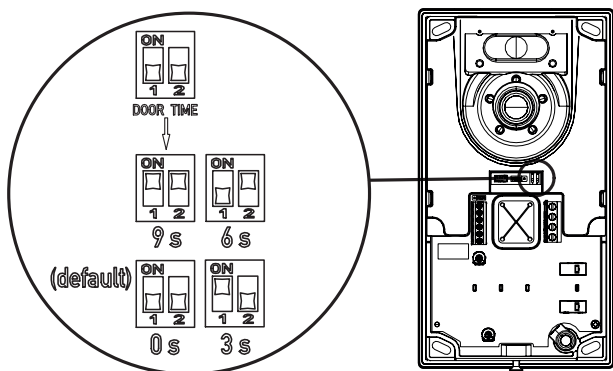

9.5. RÉGLAGE ACTIVATION /DÉSACTIVATION LED DE LA CAMÉRA

La position du cavalier à l'intérieur du dispositif permet d'allumer ou d'éteindre la LED de la caméra. Cette opération ne devra être exécutée que si la plaque de rue est installée dans un endroit suffisamment éclairé, le jour comme la nuit. Pour désactiver la led de la caméra, agir sur le cavalier indiqué dans la figure.

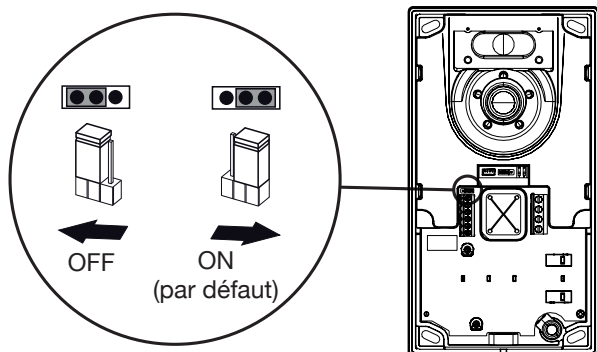

9.6. RÉGLAGE DU NIVEAU PHONIQUE DU HAUT-PARLEUR

Les niveaux phoniques sont réglés en usine et ne doivent pas être modifiés dans la plupart des installations.

Si une modification est nécessaire, agir sur le réglage du volume du haut-parleur à l'aide d'un tournevis.

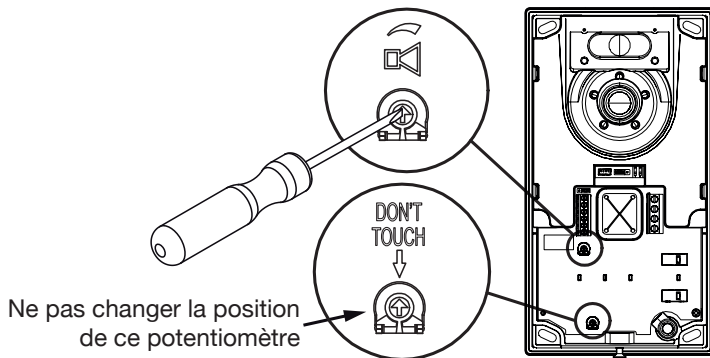

10. FONCTIONNEMENT

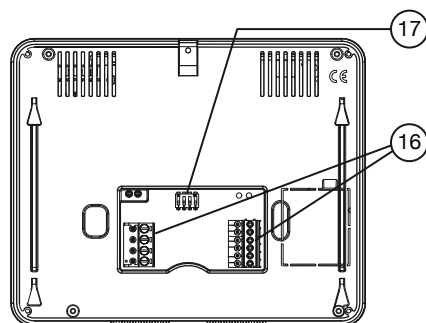
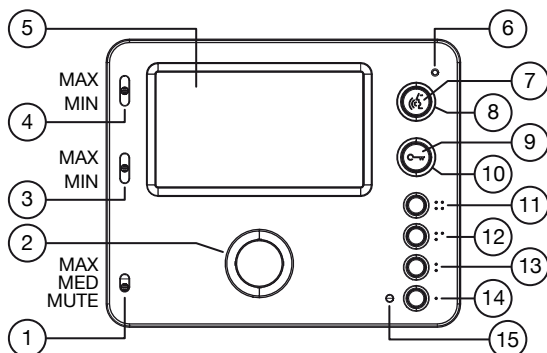

10.1. DESCRIPTION DE LA FAÇADE DU MONITEUR

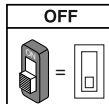
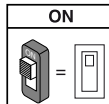
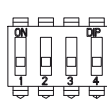

- Réglage du volume d'appel (MAXI, MOYEN, MUTE)
- Haut-parleur d'appel et de conversation
- Réglage de la luminosité de l'afficheur
- Réglage d'intensité de la couleur de l'afficheur
- Afficheur 4,3", format 16:9
- Microphone
- Touche d'activation/désactivation phonie
- LED rouge/vert située au-dessous de la touche
- Touche ouvre-porte
- LED verte située au-dessous de la touche
- Touche pour la connexion à des dispositifs Yokis; contacts Y1, Y2: maxi 50 mA à 12 V=
- Touche pour la connexion à des dispositifs Yokis; contacts X1, X2: maxi 50 mA à 12 V=
- Touche : surveillance
- Touche : ouverture passage pour véhicules (OP6)
- LED de signalisation multicolore
- Bornes de connexion au système
- Commutateurs de configuration:
 - n.1-2: code du moniteur;
 - n.3: association bouton d'appel à moniteur;
 - n.4: terminaison de ligne.





10.1.1 Fonctions des touches

Etat Touche	REPOS	ATTENTE DECROCHAGE (RECEPTION APPEL)	PHONIE	REPOS ET TOUCHE  ENFONCEE	ETAT DE PROGRAMMATION (UNIQUEMENT SI MONITEUR AU REPOS)
	[Confirmation de l'association de la fonction intercom entre moniteurs]	Ouvre-porte piétons	Ouvre-porte piétons	Ouvre-porte piétons	---
	---	Activation de la phonie	Brièvement enfoncé, active ou met fin à la conversation	---	---
•	Surveillance	Transfert vidéo	---	Appel intercom 2 programmable (par défaut: non programmé)	[Demande d'association de la fonction intercom entre moniteurs] (*)
•	Accès à la programmation (si enfoncé pour 5 secondes)	Ouverture passage pour véhicules	Ouverture passage pour véhicules	Appel intercom 1 programmable (par défaut: non programmé)	Choix de la sonnerie d'appel interphone (5 sonneries différentes) / [Demande d'association de la fonction intercom entre moniteurs] (*)





(*) Si enfoncé pendant au moins 3 secondes jusqu'au signal sonore de confirmation (voir par. 7.4 PROGRAMMATION DE LA FONCTION INTERCOMMUNICATION)

10.1.2 Signalisations par led

8. LED située au-dessous de la touche 
 - Rouge: appel en cours
 - Vert: conversation en cours
10. LED verte située au-dessous de la touche 
 - Lumière fixe: possibilité d'ouverture porte
15. Led rouge de programmation
 - Allumé clignotant: état de programmation actif

10.2. RÉCEPTION DE L'APPEL



En appuyant sur le bouton d'appel, les événements suivants se produiront:

- Les diodes de la caméra s'allument;
- Le rétro-éclairage de l'étiquette porte-nom s'éteint temporairement;
- Les moniteurs émettent la tonalité d'appel;
- Le moniteur "Maître" affiche l'image de la caméra de la plaque de rue; la touche  s'allume en vert et la touche  en rouge.
- Sur les moniteurs «Esclave» s'allument les touches  verte et  rouge.



Si aucune touche n'est appuyée dans 3 minutes qui suit l'appel, le moniteur revient en mode veille.

À la suite d'un appel, il est possible d'exécuter les opérations suivantes sur le moniteur "Maître":







- Activer la phonie à l'aide de la touche  : après avoir activé la phonie, la touche s'allume en vert; il est alors possible de converser avec l'appelant pendant un maximum de 3 minutes (la conversation peut être interrompue à tout moment en appuyant une nouvelle fois sur la touche );



Quand la phonie est active, les leds pour le rétro-éclairage de l'étiquette porte-nom s'éteignent.

10.3. GESTION DE L'APPEL INTERCOMMUNICATION

Pour effectuer un appel intercommunication:

- Appuyer sur le bouton  qui se met ensuite à clignoter sur le vert;
- Appuyer sur le bouton  ou  pour envoyer l'appel au moniteur avec lequel on entend établir une conversation (voir la procédure boutons au § 7.4 PROGRAMMATION DE LA FONCTION INTERCOMMUNICATION);
- Pendant l'attente de la réponse, la led du bouton  est allumée fixe de couleur rouge;
- Quand le moniteur appelé répond, la led du bouton  reste allumée fixe de couleur verte pendant toute la durée de la conversation;
- Appuyer à nouveau sur la touche  pour interrompre la conversation.

10.4. TRANSFERT VIDÉO



Si dans le système il y a des moniteurs «Esclave» (OP3), à la suite d'un appel tous les moniteurs en séquence émettent une tonalité d'appel. Si l'appel provient d'une plaque de rue, l'appel active aussi l'allumage du moniteur. Dans ce cas, pendant le temps d'attente de décrochage (3 minutes à partir de l'appel) les autres moniteurs peuvent allumer leur écran en appuyant sur la touche surveillance  (fonction « transfert vidéo ») jusqu'à ce que l'un des moniteurs réponde.

Après l'activation de la phonie, l'image provenant de la caméra principale sera affichée seulement sur le poste interne qui a répondu.

Il est donc normal que l'image de la caméra soit affichée sur un seul moniteur à la fois.



10.5. OUVERTURE DES PORTES

Pendant un appel, pendant une communication (phonie active) ou pendant la surveillance il est possible de:

- activer la serrure électrique piétonne en appuyant sur la touche  ;
- activer l'ouvre-porte du portail en appuyant sur la touche  .



10.6. SURVEILLANCE

En appuyant sur le bouton  , il est possible d'afficher sur le moniteur l'image provenant de la caméra de la plaque de rue.

La vidéosurveillance s'effectue en mode silencieux (sans phonie) et sans allumer les diodes de la caméra de la plaque de rue. Pendant la vidéosurveillance, l'écran du moniteur affiche les images provenant de la caméra ; la touche  s'allume en vert et la touche  en rouge.

Pour quitter la fonction surveillance, appuyez sur la touche  (dans tous les cas, au bout de 3 minutes, le dispositif s'éteint).

Lorsque le moniteur affiche les images provenant de la plaque de rue il est possible:

- d'activer la phonie pour communiquer avec l'extérieur en appuyant sur la touche  (la conversation peut être interrompue à tout moment en appuyant une nouvelle fois sur la touche ).

 L'activation de la phonie entraînera aussi l'allumage des diodes de la caméra.

10.7. COUPURE DE LA TONALITÉ D'APPEL

Il est possible de régler le volume d'appel jusqu'à l'exclusion de la sonnerie (Mute) en utilisant le curseur à glissière 1 (voir par. 10.1 DESCRIPTION DE LA FAÇADE DU MONITEUR).

L'état de mute est signalé par une indication de couleur rouge sur la partie supérieure du curseur.

 Si le curseur est dans la position MUTE, en cas d'appel, le module du moniteur s'allume; en outre, tous les signaux sonores (bips) et les éventuelles sonneries supplémentaires sont désactivés.

10.8. SONNERIE ADDITIONNELLE

Les moniteurs sont équipés d'une paire de bornes (K, Z) pour le raccordement d'une sonnerie supplémentaire. Cette sonnerie est activée en même temps que n'importe quelle tonalité d'appel.

10.9. CHOIX DE LA TONALITÉ D'APPEL DU MONITEUR

Dans les systèmes avec plusieurs moniteurs il peut être utile de choisir une tonalité d'appel différente pour chaque dispositif.

- Avec le système au repos, pour accéder à la fonction de choix de la tonalité d'appel, rester appuyé sur la touche ● pendant 5 secondes, la confirmation de l'accès à la programmation est donnée par le clignotement de la led rouge et par l'émission de 3 bips de confirmation;
- Appuyer sur la touche ● ;
- Le moniteur émet la tonalité d'appel;
- Appuyer à nouveau sur la touche ● pour changer de tonalité;
- Pour quitter la programmation, maintenir la touche ● enfoncée jusqu'à ce que 3 bips de confirmation soient émis et que la led rouge de programmation cesse de clignoter.

 Dans tous les cas, au bout de 10 minutes, le dispositif quitte la programmation et sauvegarde les paramètres modifiés.

11. CARACTÉRISTIQUES TECHNIQUES

Alimentation

Alimentation:.....	100-250 V~; 50/60 Hz
Puissance:.....	50 W max
Sortie secondaire:.....	34,5 V $\overline{\text{---}}$ 0,6 A continu (+0,6 A intermittent)
Puissance dissipée après une heure de fonctionnement:.....	Max 50 Wh (180 kJ)
Dimensions (LxPxH):	108 (6 modules DIN) x 90 x 61 mm 4.25 x 3.54 x 2.40"

Adaptateur bus 2 fils

Dimensions (LxPxH):	36 (2 moduli DIN) x 103 x 57 mm 1.42 x 4.06 x 2.24"
---------------------------	--

Moniteur

Tension d'alimentation:	34,5 V $\overline{\text{---}}$
Consommation Maximum:	150 mA
Au repos (installation de base):	8 mA
Puissance absorbée en cours de fonctionnement:.....	max 6 W
Ecran à cristaux liquides:	4,3" rétro-éclairé, format 16:9
Dimensions écran:.....	95 x 50 mm 3.74 x 1.97"
Résolution:	480H x 272V pixel
Délai d'allumage:.....	2 s Max
Capsule émettrice:	microphone à électret
Capsule réceptrice:	haut-parleur 45 Ω
Température de fonctionnement:.....	-5 \div +45 °C 23 \div 113 °F
Humidité maximum:	90% UR
Dimensions (L x P x H)	160 x 26 x 130 mm 6.30 x 1.02 x 5.12"







Plaque de rue

Consommation Maximum:	300 mA
Au repos (installation de base):	50 mA
Puissance absorbée en cours de fonctionnement:	max 10,4 W
Dimensions (LxPxH):	100 x 180 x 28 mm
Dimensions étiquette:.....	48 x 25 mm

Eclairage étiquettes et touches:**LED blanches**
 Degré de protection des boîtiers :..... **IP55**
 Degré de protection contre les chocs mécaniques **IK07**
 Température de fonctionnement: **-10 ÷ +50° C**
 Humidité maximum: **90% UR**
 Débit maximum contact C-NO: **1 A @ 30 V**
 Débit maximum contact SE1-SE2: **12 V~ Maxi 15 VA**

 *Les câbles utilisés doivent satisfaire la norme IEC 60332-1-2 si la section mesure au moins 0,5 mm², ou la norme IEC 60332-2-2 si la section mesure moins de 0,5 mm².*

11.1 LÉGENDES SYMBOLES

Symbole	Explication
	Tension d'alimentation continue
	Tension d'alimentation alternée
	Alimentation à double isolement
	Se reporter au manuel d'installation du dispositif
	DANGER – Présence de tensions dangereuses
	DANGER – Présence de composants critiques pour la sécurité

12.2. COLLEGAMENTO DEL KIT BIFAMILIARE SCH.1722/94 CON 3 VIDEOCITOFONI IN PARALLELO AD OGNI UTENZA
CONNECTION OF TWO-HOUSEHOLD KIT REF.1722/94 WITH 3 VIDEO DOOR PHONES IN PARALLEL FOR EACH USER
BRANCHEMENT DU KIT BI-FAMILLE RÉF.1722/94 AVEC 3 MONITEURS EN PARALLÈLE SUR CHAQUE UTILISATEUR

SV102-4010

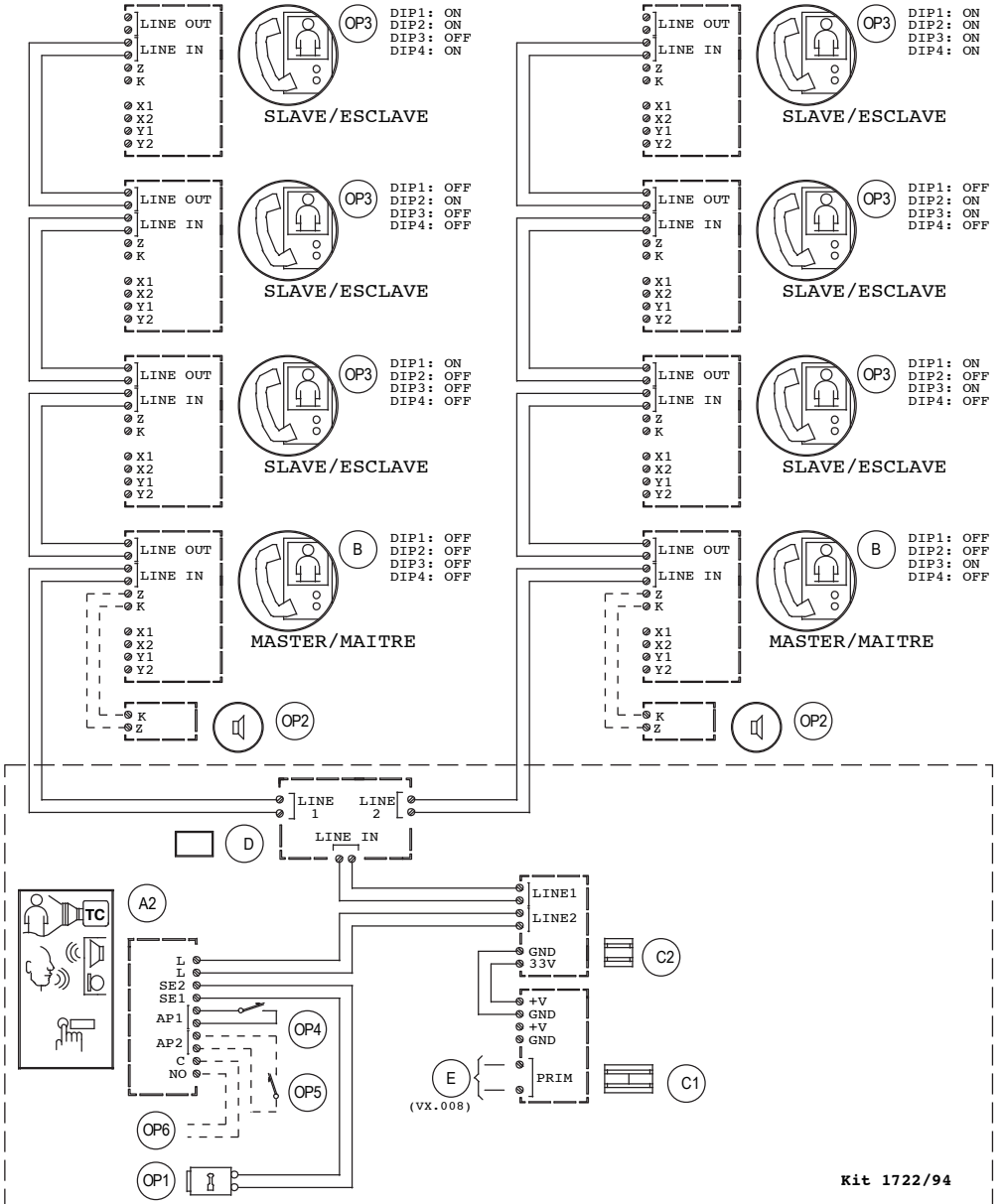

Kit 1722/94

12.2.1 Esempio di collegamento al kit di una badenia per la ripetizione della chiamata
Example of connection of call repeat brass bell to the kit
Exemple de raccordement au kit d'une sonnerie à timbre pour la répétition de l'appel

SV102-3970

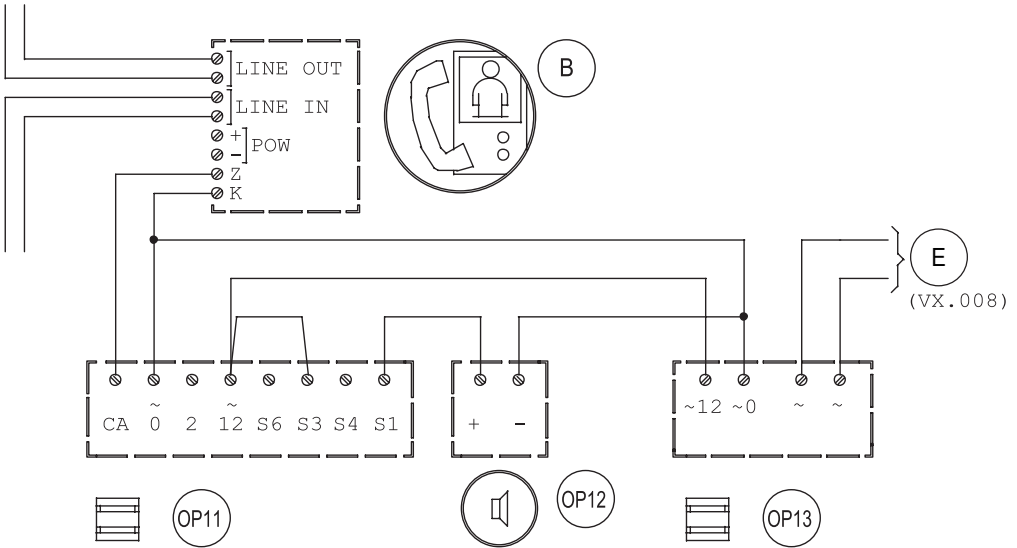

12.2.2 Esempio di collegamento al kit di due serrature elettriche con apertura contemporanea
Example of connection of two simultaneously opening electric locks to the kit
Exemple de raccordement au kit de deux serrures électriques avec ouverture simultanée

SV102-3970

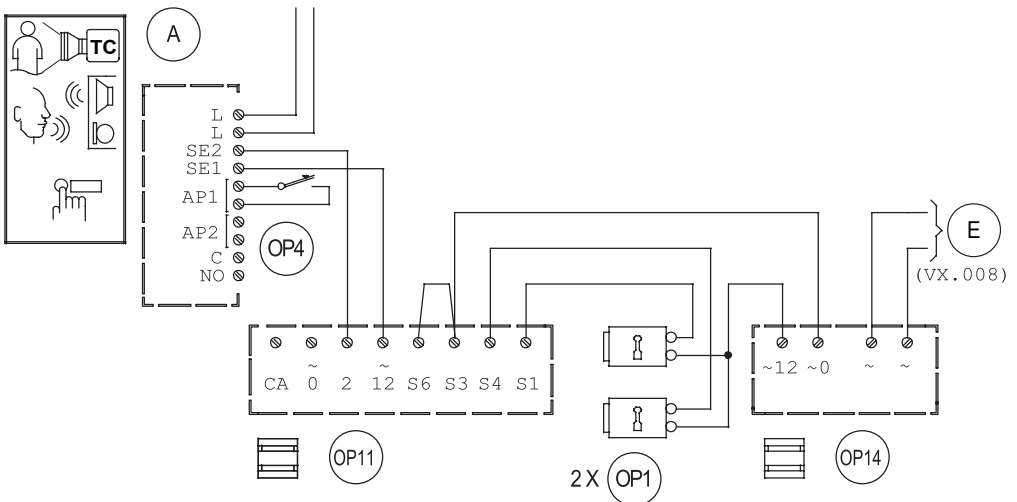

Distanze massime tra i dispositivi / Maximum distance between devices / Distances maximales entre les dispositifs

Tipo de cable / Type of wire / Type de câble								
Tratta Segment Liaison	Cavo 2Voice 2Voice cable Câble 2Voice	SYT1 (Ø 0,8 mm / AWG20)	CAT5 / CAT6	Doppino telefonico senza guaina Twisted telephone wire without sheath Cable téléphonique sans gaine Ø 0.6 mm / AWG22	Cavo singolo Single wire Cable individuel			
					0,5 mm ² / AWG20	0,75 mm ² / AWG18	1 mm ² / AWG17	1,5 mm ² / AWG15
B – OP11	30 m / 98 ft	30 m / 98 ft	30 m / 98 ft	30 m / 98 ft	30 m / 98 ft	30 m / 98 ft	30 m / 98 ft	30 m / 98 ft
OP11 – OP12	100 m / 328 ft	50 m / 164 ft	25 m / 82 ft	25 m / 82 ft	50 m / 164 ft	75 m / 246 ft	100 m / 328 ft	100 m / 328 ft
OP11 – OP13	0,5 m / 1.6 ft	0,5 m / 1.6 ft	0,5 m / 1.6 ft	0,5 m / 1.6 ft	0,5 m / 1.6 ft	0,5 m / 1.6 ft	0,5 m / 1.6 ft	0,5 m / 1.6 ft
A – OP11	30 m / 98 ft	30 m / 98 ft (*)	30 m / 98 ft	30 m / 98 ft	30 m / 98 ft	30 m / 98 ft	30 m / 98 ft	30 m / 98 ft
OP11 – OP1	40 m / 131 ft	20 m / 65 ft	10 m / 32 ft	10 m / 32 ft	20 m / 65 ft	30 m / 98 ft	40 m / 131 ft	60 m / 196 ft
OP11 – OP14	0,5 m / 1.6 ft	0,5 m / 1.6 ft	0,5 m / 1.6 ft	0,5 m / 1.6 ft	0,5 m / 1.6 ft	0,5 m / 1.6 ft	0,5 m / 1.6 ft	0,5 m / 1.6 ft

(*) Il cavo SYT1 contiene al suo interno 2 coppie di fili; utilizzandole entrambe è possibile raggiungere la distanza di 60 m.

SYT1 wire contains two pairs of wires inside. Use both to reach a distance of 60 m.

Le cable SYT1 contient plusieurs paires; en doublant les paires il est possible d'arriver à la distance de 60 m.

**12.2.3 Legenda schemi videocitofonici / Key to video door phone diagrams
Légendes schémas vidéoportiers**

A1	Pulsantiera mod. Mikra2 monofamiliare <i>Mikra2 panel one-household</i> Plaque de rue modèle Mikra2 monofamille
A2	Pulsantiera mod. Mikra2 bifamiliare <i>Mikra2 panel two-household</i> Plaque de rue modèle Mikra2 bi-famille
C1	Alimentatore <i>Power supply</i> Alimentation
C2	Induttanza elettronica <i>Electric inductor</i> Adaptateur bus 2 fils
D	Distributore video Sch. 1722/55 <i>Video distributor Ref. 1722/55</i> Distributeur vidéo Réf.1722/55
E	Linea 110 / 230 V~ <i>110 / 230 Vac line</i> Secteur 110 / 230 V~
OP1	Serratura elettrica 12 V~ Max 15 VA <i>Electric lock 12 Vac Max 15 VA</i> Serrure électrique maximum 12 V~ 15 VA

OP2	Suoneria supplementare Sch.9854/43 <i>Supplementary ringer Ref. 9854/43</i> Sonnerie supplémentaire Réf. 9854/43
OP3	Videocitofoni supplementari "Slave" Sch.1722/88 <i>Supplementary "Slave" video door phones Ref. 1722/88</i> Moniteurs supplémentaires "Esclaves" Réf.1722/88
OP4	Pulsante androne per azionamento serratura elettrica pedonale <i>Hall button for pedestrian gate electric lock</i> Bouton de sortie pour activation de la serrure électrique piétonne
OP5	Pulsante androne per azionamento apriporta passo carraio <i>Hall button for operating garage gate lock</i> Bouton de sortie pour activation ouvre-porte du portail
OP6	Dispositivo per attivazione apriporta passo carraio (corrente max commutabile 1 A @ 30 V $\overline{\text{---}}$) <i>Garage gate lock activation device (max switching current 1 A @ 30 V$\overline{\text{---}}$)</i> Dispositif d'activation ouvre-porte d'accès véhicules (courant maxi commutable 1 A @ 30 V $\overline{\text{---}}$)
OP11	Scatola a relé Sch. 788/52 <i>Relay box Ref. 788/52</i> Relais Réf. 788/52
OP12	Badenia <i>Brass bell</i> Sonnerie à timbre
OP13	Trasformatore Sch. 9000/110 (110 V \sim) o 9000/230 (230 V \sim) <i>Transformer Ref. 9000/110 (110 V\sim) or 9000/230 (230 V\sim)</i> Transformateur Réf.9000/110 (110 V \sim) ou 9000/230 (230 V \sim)
OP14	Trasformatore 12 V \sim 30VA <i>Transformer 12 V\sim 30VA</i> Transformateur 12 V \sim 30VA

12.2.4 Note legate agli schemi videocitofonici / Notes on video door phone diagrams Notes liées aux schémas vidéoportiers

VX.008 (Rev. A)

Connettere le apparecchiature ad un filtro e a un dispositivo di protezione per la linea d'alimentazione.
Connect the devices to a filter and power line protection device.

Connecter les appareils à un filtre et à un dispositif de protection pour la ligne d'alimentation.

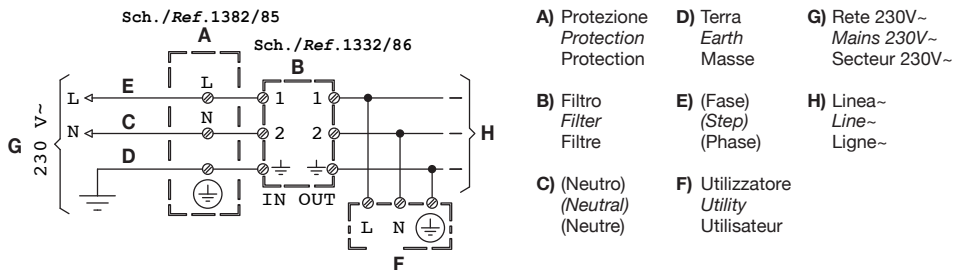

12.3. COLLEGAMENTO AL VIDEOCITOFONO MÌRO DI UN MODULO E2BPP PER LA CENTRALIZZAZIONE DI LUCI E TAPPARELLE
CONNECTION OF A E2BPP MODULE TO THE MÌRO VIDEO DOOR PHONE FOR THE CENTRALISATION OF LIGHTS AND ROLLERS
RACCORDEMENT D'UN MODULE E2BPP POUR LA CENTRALISATION DE L'ÉCLAIRAGE ET DES VOIETS ROULANTS AU MONITEUR MÌRO

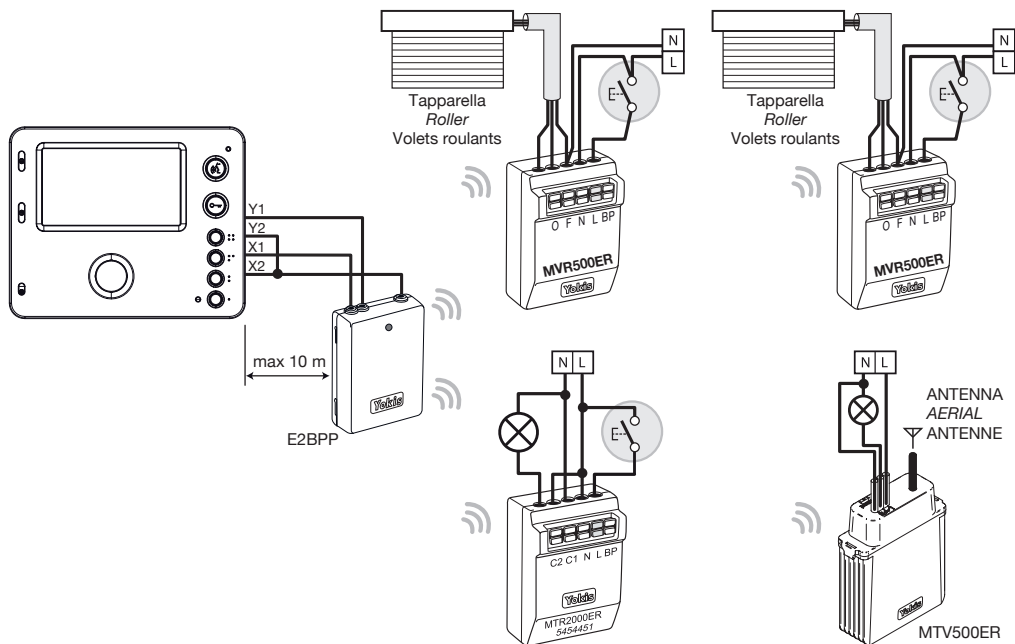

- A seguito di opportuna programmazione dei dispositivi Yokis si potrà:*
- con un pulsante ad es. ●● attivare la chiusura centralizzata delle tapparelle;
 - con un secondo pulsante (ad es. ●●●) attivare lo spegnimento delle luci.
- Per maggiori informazioni sui prodotti YOKIS andare sul sito www.yokis.com*

- After suitably programming the Yokis devices, it will be possible:*
- to activate the centralised closing of the rollers with a button (for example: ●●);
 - a second button (for example: ●●●) will activate the turning off of the lights.
- For more information on YOKIS products, please visit www.yokis.com*

- Après avoir convenablement programmé les dispositifs Yokis, il sera possible:*
- d'appuyer sur une touche (par exemple, ●●) pour activer la fermeture centralisée des volets roulants;
 - d'appuyer sur une deuxième touche (par exemple, ●●●) pour activer l'extinction de l'éclairage.
- Pour plus d'informations sur les produits YOKIS, visiter le site www.yokis.com.*

ITALIANO



DIRETTIVA 2012/19/UE DEL PARLAMENTO EUROPEO E DEL CONSIGLIO del 4 luglio 2012 sui rifiuti di apparecchiature elettriche ed elettroniche (RAEE)

Il simbolo del cassonetto barrato riportato sull'apparecchiatura o sulla sua confezione indica che il prodotto alla fine della propria vita utile deve essere raccolto separatamente dagli altri rifiuti.

L'utente dovrà, pertanto, conferire l'apparecchiatura giunta a fine vita agli idonei centri comunali di raccolta differenziata dei rifiuti elettrotecnici ed elettronici.

In alternativa alla gestione autonoma è possibile consegnare l'apparecchiatura che si desidera smaltire al rivenditore, al momento dell'acquisto di una nuova apparecchiatura di tipo equivalente.

Presso i rivenditori di prodotti elettronici con superficie di vendita di almeno 400 m² è inoltre possibile consegnare gratuitamente, senza obbligo di acquisto, i prodotti elettronici da smaltire con dimensione massima inferiore a 25 cm.

L'adeguata raccolta differenziata per l'avvio successivo dell'apparecchiatura dismessa al riciclaggio, al trattamento e allo smaltimento ambientalmente compatibile contribuisce ad evitare possibili effetti negativi sull'ambiente e sulla salute e favorisce il reimpiego e/o riciclo dei materiali di cui è composta l'apparecchiatura.

ENGLISH



DIRECTIVE 2012/19/EU OF THE EUROPEAN PARLIAMENT AND OF THE COUNCIL of 4 July 2012 on waste electrical and electronic equipment (WEEE)

The symbol of the crossed-out wheeled bin on the product or on its packaging indicates that this product must not be disposed of with your other household waste.

Instead, it is your responsibility to dispose of your waste equipment by handing it over to a designated collection point for the recycling of waste electrical and electronic equipment.

The separate collection and recycling of your waste equipment at the time of disposal will help to conserve natural resources and ensure that it is recycled in a manner that protects human health and the environment.

For more information about where you can drop off your waste equipment for recycling, please contact your local city office, your household waste disposal service or the shop where you purchased the product.

FRANÇAIS



DIRETTIVE EUROPEENNE 2012/19/UE du 4 juillet 2012 relatif aux déchets d'équipements électriques et électroniques (DEEE)

Le symbole de la poubelle sur roues barrée d'une croix présent sur le produit ou sur son emballage indique que ce produit ne doit pas être éliminé avec vos autres déchets ménagers.

Au lieu de cela, il est de votre responsabilité de vous débarrasser de vos équipements usagés en les remettant à un point de collecte spécialisé pour le recyclage des déchets des équipements électriques et électroniques (DEEE). La collecte et le recyclage séparés de vos équipements usagés au moment de leur mise au rebut aidera à conserver les ressources naturelles et à assurer qu'elles sont recyclées d'une manière qui protège la santé humaine et l'environnement. Pour plus d'informations sur les lieux de collecte où vous pouvez déposer vos équipements usagés pour le recyclage, veuillez contacter votre revendeur, votre service local d'élimination des ordures ménagères.

DS 1722-139A

URMET S.p.A.
10154 TORINO (ITALY)
VIA BOLOGNA 188/C
Telef. +39 011.24.00.000 (RIC. AUT.)
Fax +39 011.24.00.300 - 323

urmet

LBT 20827

Area tecnica
servizio clienti +39 011.23.39.810
<http://www.urmet.com>
e-mail: info@urmet.com

MADE IN CHINA